

Precision rail guides catalogue



Contents

1 Introduction	4	2.6.2 Determination of resulting deflection of a rail guide system	42
1.1 General information	5	2.6.3 Calculation example for the resulting deflection....	43
1.2 Product overview	6	2.7 Technical data of precision rail guides with slide coating	44
1.3 ACS in general	8	2.7.1 Surface pressure	44
1.4 Ewellix precision rail guides in kit packaging	10	2.7.2 Wear	44
1.5 Features and benefits	11	2.7.3 Frictional properties	45
2 Selection Guide	12	2.7.4 Temperature range	45
2.1 Technical data	13	2.7.5 Chemical and humidity resistance	45
2.1.1 Materials	13	2.8 Legend	46
2.1.2 Coating	13	3 Product Range	48
2.1.3 Permissible operating temperatures.....	13	3.1 LWR / LWRB	49
2.1.4 Permissible speed and acceleration.....	13	3.2 LWRE	54
2.1.5 Required minimum load	14	3.3 LWRE ACS	59
2.1.6 Permissible maximum load.....	14	3.4 LWRE / LWRB ACSM	63
2.1.7 Friction.....	14	3.5 LWRM / LWRV	67
2.1.8 General rigidity behaviour.....	14	3.6 LWM / LWV	71
2.1.9 Precision classes of rails.....	15	3.7 LWM / LWV ACSZ	75
2.1.10 Precision of rolling elements	15	3.8 LWRPM / LWRPV	79
2.1.11 Dimensional accuracy	16	3.9 Other products	82
2.1.12 Grading	16	3.9.1 LWML / LWV.....	82
2.1.13 Jointed rails.....	16	3.9.2 LWN / LWO	82
2.2 Dimensioning of precision rail guide systems	17	3.9.3 LWJ / LWS flat rail guides.....	82
2.2.1 The concept of static safety factor calculation	17	3.10 GCL / GCLA standard slides	83
2.2.2 The method of static safety factor calculation.....	18	3.11 LZM miniature slide	88
2.2.3 Rating life	18	4 Mounting Instruction and Manual	92
2.2.4 Rating life calculation	19	4.1 Design rules	93
2.2.5 Service life	19	4.1.1 Designated use.....	93
2.2.6 Cross reference to related chapters.....	19	4.1.2 Typical mounting – clamped arrangement	93
2.2.7 Dimensioning tool	19	4.1.3 Accuracy of mounting surfaces.....	93
2.3 Determination of effective load ratings	20	4.1.4 End pieces logic.....	94
2.3.1 Static and dynamic load ratings given in the catalogue.....	20	4.1.5 Chamfers on the precision rail guides.....	95
2.3.2 Influence of hardness	21	4.1.6 Tolerance of distance between mounting holes.....	95
2.3.3 Influence of operating temperature.....	21	4.1.7 Calculation of J_1 dimension.....	95
2.3.4 Rail guide arrangements	22	4.1.8 Special mounting screws LWGD	96
2.3.5 Rail guide kinematics.....	23	4.1.9 Preloading	96
2.3.6 Number of rolling elements z , z_r	25	4.1.10 Tightening torques for mounting screws	98
2.3.7 General geometry of a rail guide system	26	4.2 Mounting	99
2.4 Calculation of bearing loads	27	4.2.1 Important requirements	99
2.4.1 Transfer of external loads to F_y , F_z , M_x , M_y , M_z	27	4.2.2 General mounting rules	99
2.4.2 Preload force	28	4.2.3 Mounting of rail guides without Anti-Creeping System ..	99
2.4.3 Transfer of F_y , F_z , M_x , M_y , M_z to one load	28	4.2.4 Mounting of rail guides with Anti-Creeping System	100
2.4.4 Influence of stroke length on equivalent dynamic load	29	4.3 Maintenance	101
2.4.5 Equivalent dynamic mean load	29	4.3.1 Lubrication	101
2.4.6 Maximum resulting load	30	4.3.2 Relubrication interval.....	101
2.4.7 Elaborated equation for the static safety factor.....	30	4.3.3 Repairs.....	101
2.4.8 Elaborated equation for the rating life	30	4.3.4 Stationary conditions / shipping / storage.....	101
2.5 Example dimensioning calculation	31	5 Ordering Key	102
2.6 Rigidity calculation	36	6 Specification Sheet	108
2.6.1 Determination of elastic deformation using the nomogram	36		

The heritage of innovation

Ewellix is a global innovator and manufacturer of linear motion and actuation solutions used in assembly automation, medical applications and mobile machinery. Formerly part of SKF Group, the Ewellix Group consists of 16 sales units and eight factories. External net sales are approximately 2.3 SEK billion and we employ around 1 200 people. Ewellix is headquartered in Gothenburg, Sweden and is owned by Triton.

Technology leadership

Our journey began **over 50 years** ago as part of the SKF Group, a leading global technology provider, with the world's first precision ball and roller screw factories. Our history with SKF provided us with the **expertise to continuously develop new technologies** and use them to create cutting edge products that offer our customers a competitive advantage.

In 2019, we became independent from SKF and changed our name to Ewellix. **We are proud of our heritage.** This gives us a unique foundation on which to build an agile business with engineering excellence and innovation as our core strengths.

Global presence and local support

With our **global presence**, we are uniquely positioned to deliver **standard components and custom-engineered solutions**, with full technical and applications support around the world. The long lasting relationships with our distributor partners allow us to support customers in a variety of different industries. At Ewellix, we don't just provide products; **we engineer integrated solutions** that help customers realise their ambitions.



1200 employees



16 sales units



8 factories

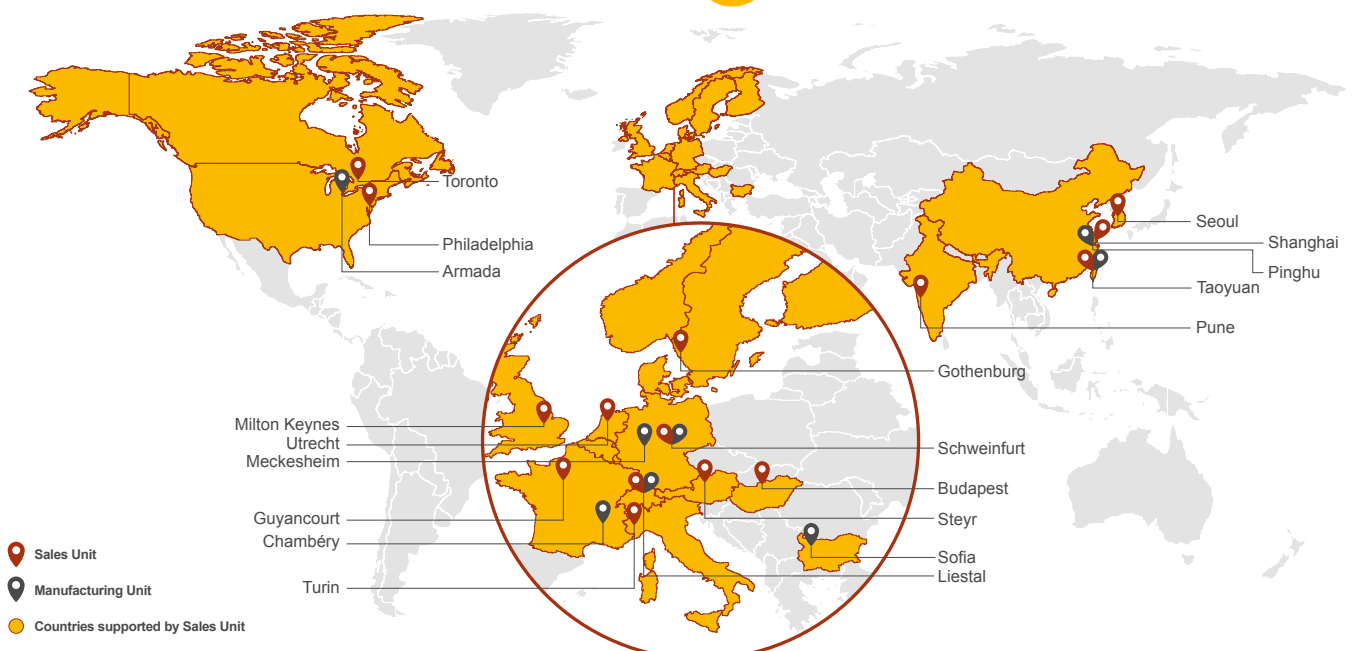

Trusted engineering expertise

Our industry is in motion; pushing towards solutions that reduce environmental impact and leverage new technology. We provide technical and manufacturing expertise to overcome our customers' challenges.

Engineering for the future

We work in a **wide range of industries**, where our solutions provide key functionality for business critical applications.

For the **medical industry**, we provide precision components for use in core medical equipment.

Our unparalleled understanding of **industrial automation** systems is based on decades of research into advanced automation components and techniques.

Our deep knowledge of **mobile machinery** provides powerful and reliable electromechanical solutions for the harshest conditions. In an **industrial distribution** setting, we supply linear expertise to our partners, empowering them to serve customers with greater efficiency.

We offer excellence

We have a **unique understanding of linear equipment** and how it's integrated in customers' applications to provide the best performance and machine efficiency.

We assist our customers by creating equipment that runs faster, longer and that is safe and sustainable.

We provide a wide variety of **linear motion components** and **electromechanical actuators** for equipping any automation application, thus helping our customers **reduce their footprint, energy use and maintenance**.

We push for lower energy consumption that **increase productivity and reduce the environmental impact**.

Actuation systems



Ball and roller screws



Linear guides and systems

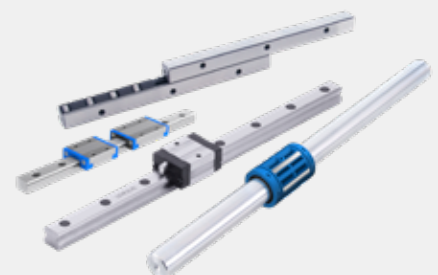

1

Introduction

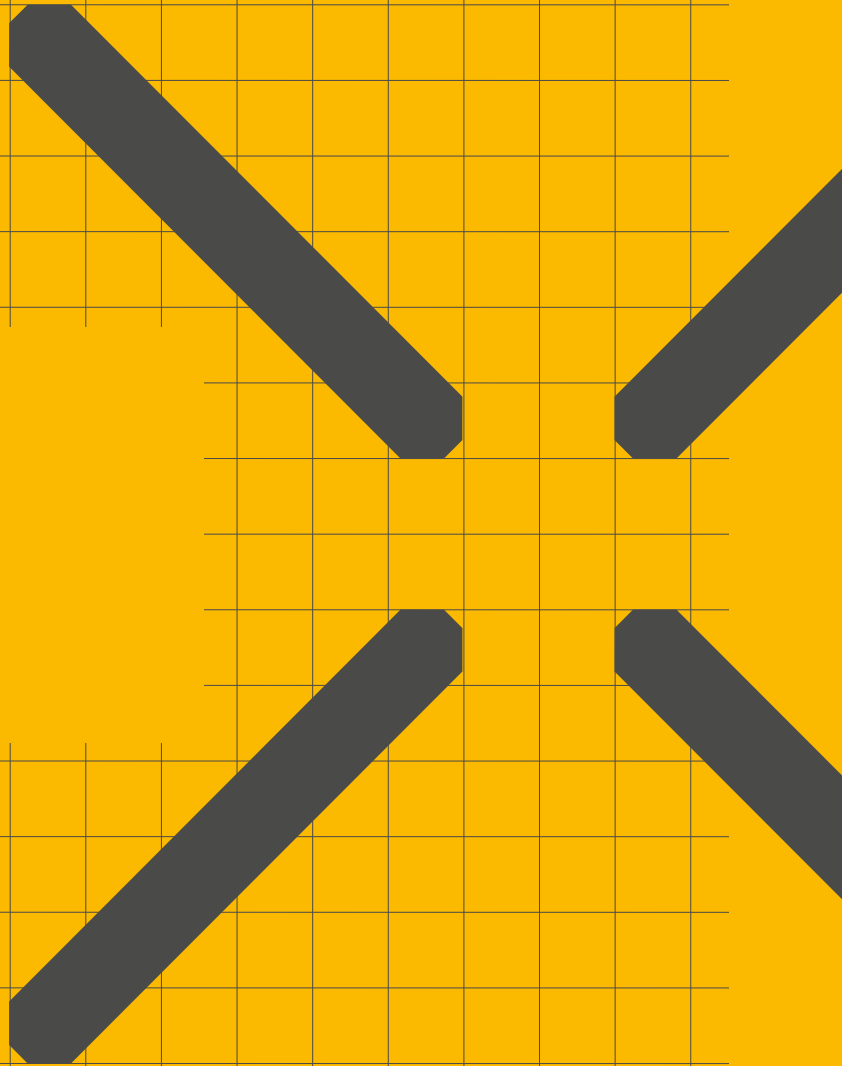

1.1 General information

As a global innovator and manufacturer of linear motion and actuation solutions, Ewellix is in a position, both technically and economically, to meet almost any customer requirement.

This catalogue covers the entire range of Ewellix precision rail guides and accessories. Ewellix precision rail guides are highly accurate products for linear motion and are ideally suited for use in a wide variety of machine tools, machining centres, handling systems and special machinery, as well as in measuring and testing equipment and semi-conductor production machines.

Ewellix precision rail guides are available in many different designs, sizes and standard lengths and which incorporate ball, roller or needle roller assemblies and slide coatings, depending on application requirements. They are supplied with the required accessories for attachment and sealing. The use of Ewellix precision rail guides enables the construction of economical, clearance-free linear guides of almost any type and length, according to the building block principle.

The characteristics of the precision rail guides include:

- A constant, high degree of running accuracy.
- Low-friction, stick-slip free operation.
- High speed of travel.
- Low heat generation.
- Low wear and high reliability.
- High rigidity.
- Excellent load carrying capacity.

If cage creeping is likely, in particular when the guide is mounted vertically, precision rail guides with anti-creeping systems (ACS) are an obvious choice, as they will eliminate this problem. They are available for nearly all types of rolling elements.

For applications characterized by high accelerations or short strokes of high frequency, Ewellix rail guides with slide coating are recommended. These rail guides are also suitable for machine tool applications where the damping properties of the guides are of greater importance than is the lower friction of rolling element rail guides. For those applications where precision rail guides are unsuitable, for instance because of their limited travel, Ewellix can supply alternative forms of linear guidance systems, like profile rail guides or linear ball bearings.

All fast-selling precision rail guides are also available in convenient kit packaging. This ensures the complete delivery of all components including end pieces and screws in one package from stock.

This catalogue brings together all the basic data that we believe will be of interest to customers. For further specialized advice, please contact your nearest Ewellix sales office.

1.2 Product overview

Ewellix offers a large assortment of precision rail guides (→ **table 1**). The different versions, mainly characterized by the type of rolling elements used, are as follows:

- Ball assemblies of LWRB series.
- Ball assemblies with Anti-Creeping System of LWRB ACSM series.
- Crossed roller assemblies of standard LWR series.
- Crossed roller assemblies of optimized LWRE series.
- Crossed roller assemblies with Anti-Creeping System of LWRE ACS series.
- Crossed roller assemblies with Anti-Creeping System of LWRE ACSM series.
- Needle roller assemblies of LWRM/LWRV series.
- Needle roller assemblies of LWM/LWV series.
- Needle roller assemblies with Anti-Creeping System of LWM/LWV ACSZ series.
- Slide coating of LWRPM/LWRPV series.



The **table 1** shows the complete range of Ewellix precision rail guides, together with all available sizes. The blue shaded areas indicate the sizes included in the Modular Range. Contrary to the current lack of uniformity within the market, the interchangeable precision rail guides of the Modular Range are all within the same outer dimensions (↳ **fig. 1**). For fast delivery, please refer to the rail guides that are available in kit packaging.

Fig. 1

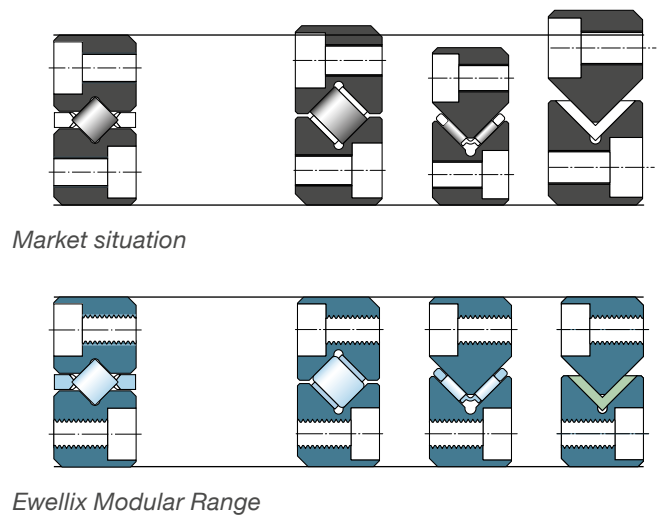

Table 1

Product overview

Type		Size (A x B mm)																								
		1	2	3	2211	4	6	9	12	15	8,5x4	12x6	18x8	22x11	25x12	30x15	31x15	40x20	44x22	50x25	58x28	60x35	70x40	71x36	80x50	
LWRB		X	X	-	-	-	-	-	-	-	-	-	-	-	-	-	-	-	-	-	-	-	-	-	-	-
LWRB ACSM		-	○	-	-	-	-	-	-	-	-	-	-	-	-	-	-	-	-	-	-	-	-	-	-	-
LWR		-	-	X	-	-	-	X	-	X	-	○	-	-	-	-	-	-	-	-	-	-	-	-	-	-
LWRE		-	-	X	○	X	-	X	-	X	-	-	-	-	-	-	-	-	-	-	-	-	-	-	-	-
LWRE ACS		-	-	X	○	○	-	X	-	○	-	-	-	-	-	-	-	-	-	-	-	-	-	-	-	-
LWRE ACSM		-	-	X	○	○	-	X	-	○	-	-	-	-	-	-	-	-	-	-	-	-	-	-	-	-
LWRM / V		-	-	-	-	-	-	X	-	X	-	-	-	-	-	-	-	-	-	-	-	-	-	-	-	-
LWM / V		-	-	-	-	-	X	-	X	-	X	-	○	○	-	○	-	-	-	-	-	-	-	-	-	○
LWM / V ACSZ		-	-	-	-	-	○	-	○	-	○	-	○	○	-	○	-	-	-	-	-	-	-	-	-	○
LWRPM / V		-	-	X	-	-	-	X	-	X	-	-	-	-	-	-	-	-	-	-	-	-	-	-	-	-

X = Prompt delivery in standard lengths (see specific product tables) = Modular Range
 ○ = Delivery time on request
 - = Not available

1.3 ACS in general

Many users are familiar with “cage-creeping” in conventional precision rail guides. This occurs when the cage moves out of its intended position, adversely affecting performance and possibly requiring service. This effect may occur, for example, as a result of high acceleration, uneven load distribution or vertical mounting. Ewellix has solved this problem by offering highly sophisticated Anti-Creeping Systems (ACS) for most types of guides.

Advantages:

- Cage-creeping eliminated.
- Suitable for high acceleration, vertical mounting and uneven load distribution.
- Increased accuracy due to defined position of the cage.
- Easily interchangeable with standard precision rail guides because they have identical dimensions.
- Less downtime and maintenance.

LWRE with ACS

The original anti-creeping system for all types of LWRE rail guides.

LWRE with ACSM

Refinement of our own ACS solution led to version ACSM for LWRE rail guides with a maximum length of 400 mm. The rolling element assembly, with an involute-toothed control gear made of brass, and a rack directly machined into the rail is especially suitable for high accelerations.

LWM / LWV with ACSZ

For precision rail guides with needle roller assembly, Ewellix offers version ACSZ.

Both rails are equipped with gear racks made of steel. The cage carries two steel control gears that help to ensure the correct position of the cage.

LWRE with ACS



LWRE with ACSM



LWM / LWV with ACSZ



Rails for anti-creeping cages

All rails for anti-creeping cages are toothed over their entire length as standard. To save costs it is possible for ACS and ACSZ rails, to specify a stroke with the tothing in the rails produced accordingly (**fig. 2 and 3**).

For rails with a specified stroke, the length of the stroke, which is symmetrical to the rail, must be stated in millimetres after the suffix ACS or ACSZ.

ACS and ACSZ cages must be operated only along the specified stroke length to ensure that the control gear is not damaged. It is therefore recommended to use the theoretical possible stroke as specified stroke. In case of kinematic “not overrunning without wiper”, that stroke is defined by the length of ordered cage and the length of rail.

Ordering example - standard:

4x LWRE 6500 ACS

2xWAKE 6x30 ACS

8x LWERE 6

Ordering example – specified stroke of 340 mm:

4x LWRE 6500 ACS 340

2x LWAKE 6x30 ACS

8x LWERE 6

Ordering example – kit packaging:

LWRE 6200 ACSM-KIT

Fig. 2

LWRE ACS standard stroke

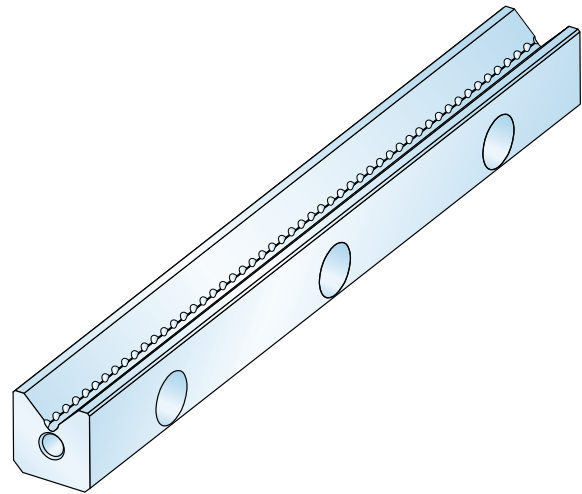
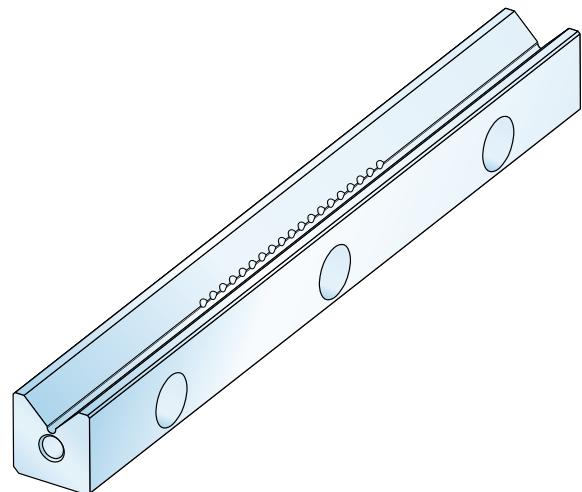

Fig. 3

LWRE ACS specified stroke



1.4 Ewellix precision rail guides in kit packaging

To simplify the ordering process and stock-keeping for our customers, Ewellix offers precision rail guides in pre-defined kits. Each kit consists of 4 rails in precision class P10, 2 rolling element assemblies and 8 end pieces (ACSM kits without end pieces). The available kits can be found in the specific rail guide chapters. With delivery time on request it is possible to order a kit with two rails in standard length and two short rails with lead in radius. For kinematic “overrunning” (↳ **chapter 2.3.5**). For kinematic “with wiper” and suffix E7 the two short rails will be equipped with threads for fastening the wipers. Additionally the number of rolling elements can be varied, see ordering code.

Completely customized precision rail guide sets are also possible on request.

Advantages of rail guide kits

All components required are supplied ready-to-mount and can be ordered with a single order number.

- Most kits are available from stock.
- The length of the rolling element assembly is easily adjustable.¹⁾
- Load capacities are already calculated for the kit.²⁾
- Available with ACS or ACSM for effective prevention of cage-creeping.
- Rails for ACS or ACSM cages with tothing along entire length.

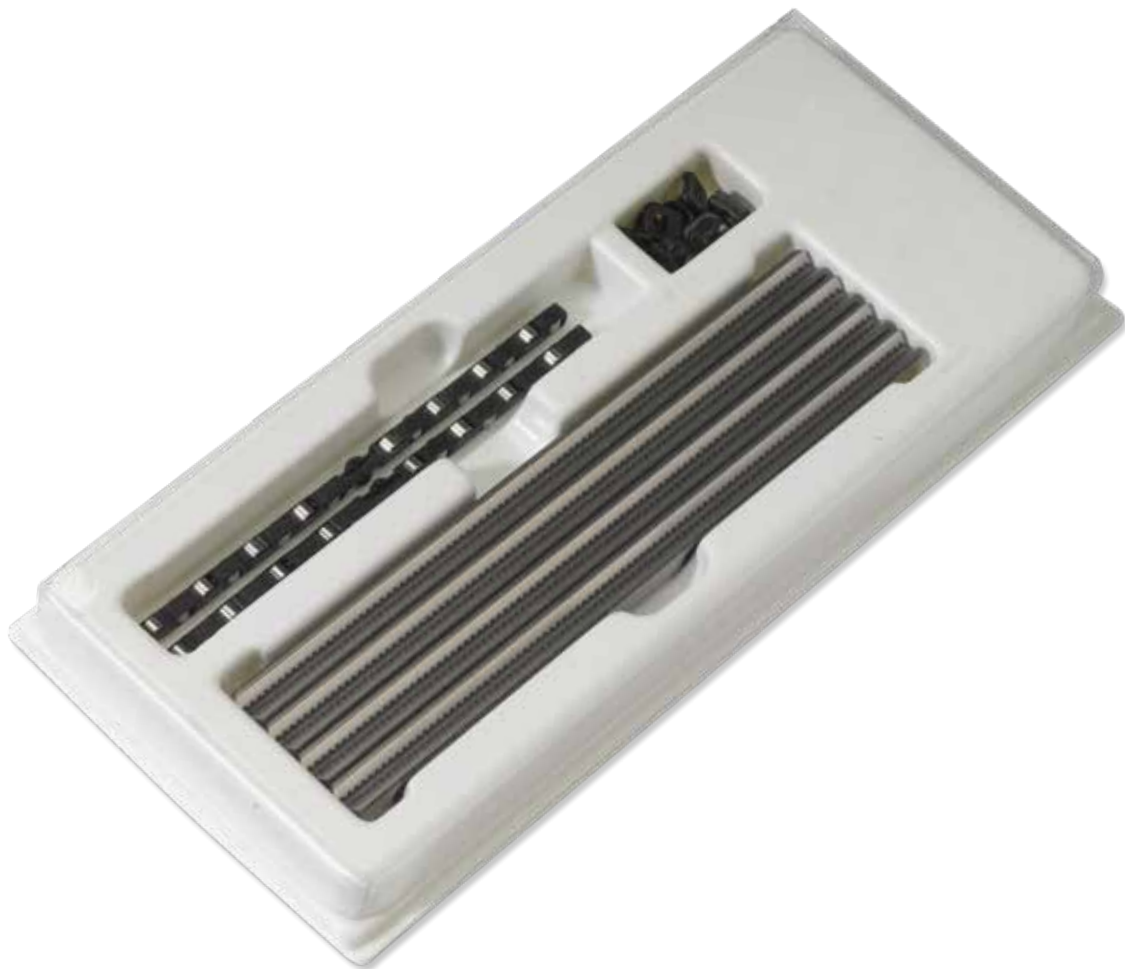

¹⁾ Do not cut the cage shorter than 2/3 of the total rail length.

²⁾ Load capacities are given for a kit of 4 rails and 2 rolling element assemblies in clamped arrangement ($C_{0, \text{eff slide}}$, $C_{\text{eff slide}}$) and for standard stroke, given in the product tables.

1.5 Features and benefits

Anti-creeping system

Ewellix developed the industry's first anti-cage-creep solution. It keeps the movement of the rolling element assembly in the required position at the loaded zone, avoids cage creep from high operational speed and acceleration to uneven load distribution and weak adjacent parts, and prevents unplanned downtime and additional maintenance.

In addition, due to the defined position of the cage, Ewellix precision rail guides with anti-creeping system, or ACS, enable increased accuracy, higher accelerations (tested up to 160 m/s²) and reliable vertical installation.

Cage creep test results

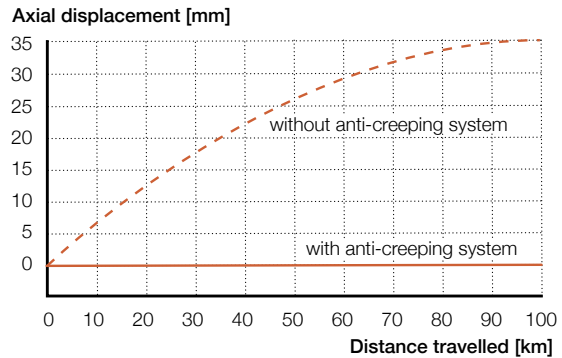

Higher load rating and rigidity

Compared to conventional LWR precision rail guides, Ewellix optimized the internal geometry and developed LWRE precision rail guides for applications that demand robust performance. Part of our Modular Range, LWRE precision rail guides feature rollers with a 33% larger diameter and utilize the entire roller length than those in LWR rail guides. These LWRE guides offer five times higher load ratings and twice the rigidity in comparison with LWR rail guides. In operation, the increased load rating and rigidity helps to increase process stability and reliability, ultimately extending equipment service life and reducing total cost of ownership.

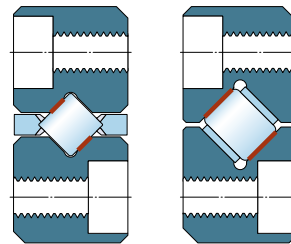

Permissible deviation in parallelism between reference surfaces and raceways

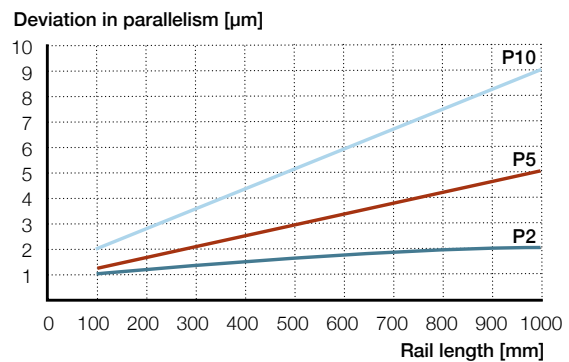

Extreme accuracy and positioning repeatability

Compared to other linear guiding products, precision rail guides provide the highest linear guiding accuracy. Precision rail guides from Ewellix are available in three different precision classes to meet a range of requirements for precision. The increased accuracy and repeatability enables higher productivity and product quality in diverse applications, e.g. semi-conductors, machine tools, measurement and testing equipment, and medical equipment.

Modular Range

With the Ewellix Modular Range of precision rail guides, outer rail dimensions remain the same, but rolling elements are interchangeable to best meet application demands. With this design modularity, customers can easily increase load ratings or extend the rating life without having to redesign the equipment. The Ewellix Modular Range of precision rail guides covers 80% of dimensions on the market. Additionally, the customer can choose between ball assemblies, crossed roller assemblies, crossed roller assemblies with ACS/ACSM, needle roller assemblies and slide coatings.

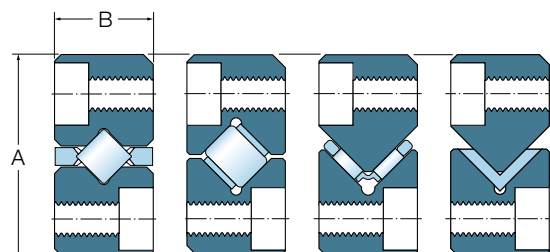

2

Selection Guide

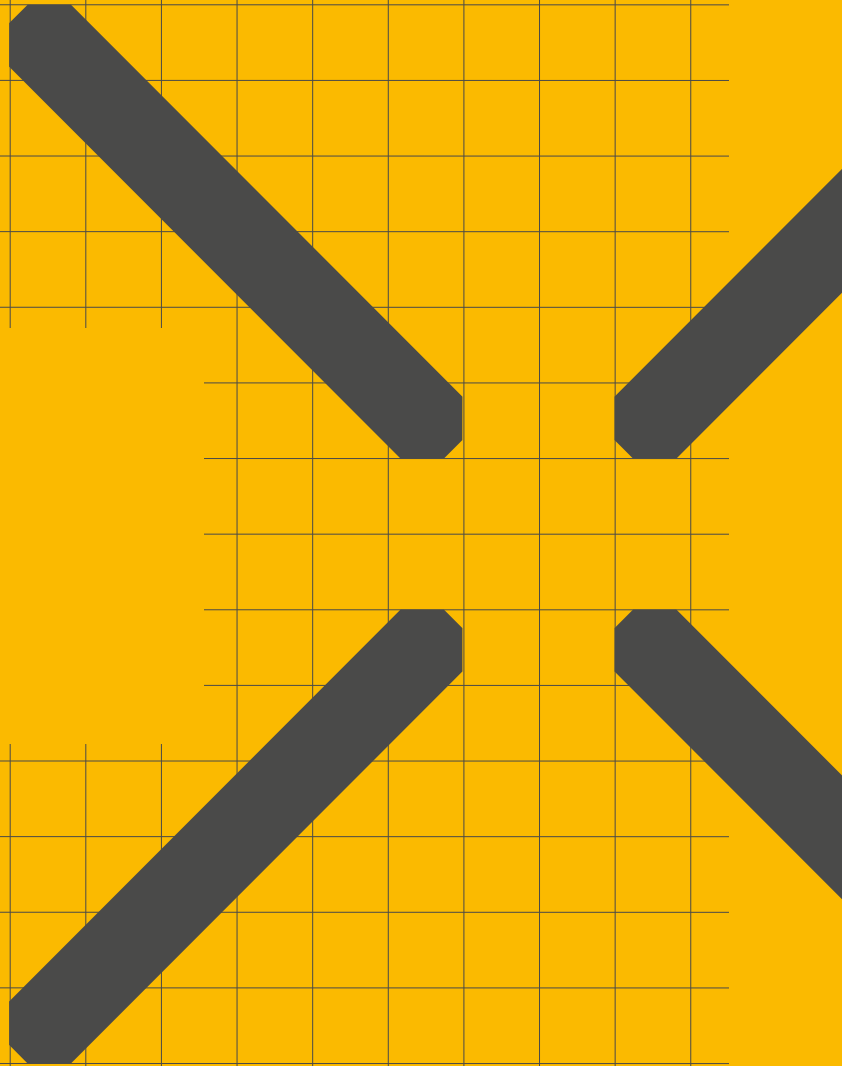

2.1 Technical data

2.1.1 Materials

As standard, precision rails are manufactured from tool steel 90MnCrV8 (1.2842) with a hardness between 58 and 62 HRC. With delivery time on request and with suffix “/HV”, the rails can also be supplied in stainless steel, e.g. X90CrMoV18 (1.4112). All rails from the LWRE ACSM series are made of stainless steel X46Cr13 (1.4034) or X65Cr13 (1.4037). The hardness of stainless steel rails is between 54 and 58 HRC.

Standard rolling elements are made from carbon chromium steel 100Cr6 (1.3505) with a hardness of between 58 and 65 HRC. Stainless steel rolling elements are available with delivery time on request.

The cages of Ewellix rolling element assemblies are manufactured from hard plastic or aluminium. The material of LWAKE crossed roller units is POM, and for all other rolling element assemblies, PA 12 or equivalent, sometimes reinforced with glass fibres. Aluminium cages are made of AlMgSi0,5 (EN AW-6060). For other cage materials such as PEEK, steel, brass, etc., please contact Ewellix.

Standard end pieces are made of blackened steel. Additionally, the standard end pieces can be supplied as chromed end pieces when ordered with suffix “/HV”.

End pieces with wiper are made from felt, thermoplastic polyurethane (TPUR) or thermoplastic polyester elastomer (TPC-ET).

2.1.2 Coating

For corrosive environments, the rails can be protected with a special TDC (Thin Dense Chrome) coating, with delivery time on request. This coating, with a layer hardness of 900 to 1300 HV, substantially improves corrosion resistance and thus increases wear resistance under critical operating conditions. The salt spray test, which complies with DIN EN ISO 9227, resulted in 72h corrosion protection. The coating is matt grey in colour and complies with RoHs requirements. The load capacity is not affected by the coating. Due to the electrolytic process, the mounting holes and other grooves or drills might not be fully coated. The suffix for ordering is “/ HD”.

2.1.3 Permissible operating temperatures

The range of operating temperatures for Ewellix precision rail guides largely depends on the particular cage type used. Guides with metal cages and end pieces without wipers can generally be used up to +120 °C. For rail guides with plastic components, the operating temperature range is –30 °C to +80 °C. Please note that the temperature limit of the used lubricant must also be taken into account.

Permanently higher operating temperatures for precision rail guides without plastic components are possible but the hardness of the material and thus the load carrying capacity will decrease. The detailed explanation of the influence of higher temperatures on the load carrying capacity (factor f_t) can be found in **chapter 2.3.3** The accuracy of the rail guide worsens with increasing temperature due to changes in the material structure and dimensional changes.

For rails equipped with ACSZ rack the maximum operating temperature is limited to 180°C.

2.1.4 Permissible speed and acceleration

Ewellix precision rail guides that are correctly mounted and preloaded, can be used for accelerations up to 25 m/s². Needle roller assemblies can be accelerated with maximum 100 m/s². For rolling element assemblies with ACSM, the maximum acceleration is 160 m/s² and for rolling element assemblies with ACSZ the value is 100 m/s². Higher accelerations are possible, depending on bearing design, bearing size, applied load, lubricant and bearing preload. In such instances, please consult Ewellix. The mentioned maximum acceleration and the limitation of the stroke by the kinematics (↳ **chapter 2.3.5**) determine the maximum running speed.

2.1.5 Required minimum load

To prevent the rolling elements from sliding on the raceway during operation at higher speeds or high acceleration, the precision rail guide system must be loaded at all times with a minimum 2% of the dynamic load rating. This is particularly important for applications characterized by highly dynamic cycles. Precision rail guide systems preloaded according to the table, **Tightening torques of mounting screws** (→ chapter 4.1.10), are typically able to satisfy the stated minimum load requirements.

2.1.6 Permissible maximum load

ISO 14728 Part 1 stipulates that calculation of bearing life is valid only when the equivalent dynamic mean load P_m of a precision rail guide does not exceed 50% of the dynamic load rating C . Any higher loading leads to an imbalance of stress distribution, which can have a negative impact on bearing life. As stated in ISO 14728 Part 2, the maximum load should not exceed 50% of the static load rating C_0 .

2.1.7 Friction

Friction in a precision rail guide with rolling elements depends not only on the loading, but on a number of other factors, notably the type and size of the guiding, the operating speed, and the properties of the lubricant. The cumulative running resistance of a rail guide is composed of the rolling and sliding friction at the contact zone of the rolling elements, friction at the points of sliding contact between the rolling elements and cage, churning within the lubricant and friction from the seals or wipers. The coefficients of friction under normal operating conditions, with grease lubrication and good mounting accuracy, are between 0,0005 and 0,004. For rail guides fitted with wipers, the coefficient of friction and the starting friction is significantly higher due to the friction of the wipers themselves.

2.1.8 General rigidity behaviour

The rigidity of a precision rail guide (expressed in $N/\mu m$) is defined as the ratio between the acting external load and the elastic deflection resulting in the rail guide. Besides the load carrying capacity, rigidity is one of the most important selection criteria for a precision rail guide system. The elastic deflection of a system depends on the magnitude and direction of the external load, the preload, the type of rail guide including size and length of the rolling element assembly, and the mechanical properties of the adjacent support structure, including screws and joints between components. On a preloaded rail guide system the deflection under load within a given load range will be less than for a rail guide without preload. Variations in contact geometry are the main factors contributing to the general rigidity behaviour of the different rolling element assemblies (→ diagram 3). The details are explained in chapter 2.6.

Diagram 3

General rigidity behaviour of different rolling elements

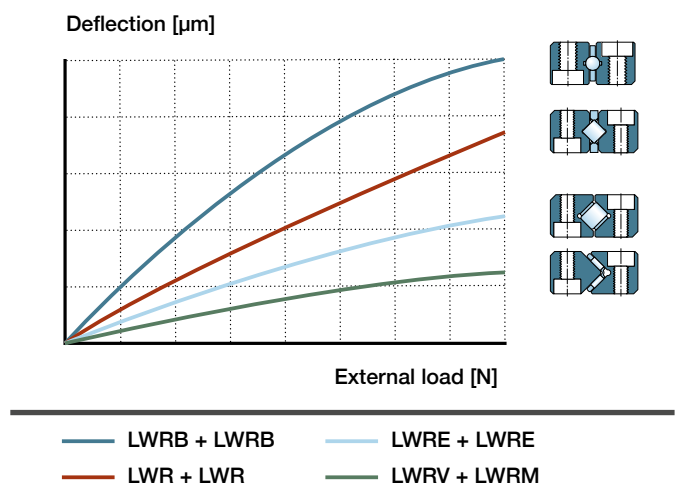

2.1.9 Precision classes of rails

In order to meet the precision requirements of rail guide systems, Ewellix produces rails in three different precision classes. These are classified according to the parallelism between the raceways and reference surfaces A, (as indicated, on the reverse side of the Ewellix label), and B. See **table 2** and **fig. 4**.

P10

This is the standard precision class and meets the requirements of general machinery. The tolerance of parallelism for a 1 000 mm long rail is maximum 9 µm.

P5

Precision class P5 satisfies the demands normally made on the running accuracy for machine tool applications. The tolerance of parallelism for a 1 000 mm long rail is 5 µm maximum.

P2

Precision class P2 is for the most exacting demands. Rails made to this precision class should only be used when the associated components are manufactured to a correspondingly high degree of precision. Rails of precision class P2 will be manufactured by Ewellix to special order. If the requisite accuracy on the order is not specified, rails with standard P10 tolerances will be supplied.

2.1.10 Precision of rolling elements

The rolling elements used in precision rail guide cages are of very high quality and have a specification according to **table 3**. Besides the standard type, needle roller assemblies can be delivered in class G1, when ordered with suffix /G1.



Table 2

Tolerance *t* of parallelism to reference surfaces

Rail length		Precision class		
> mm	≤ µm	P10	P5	P2
0	100	2	1	1
100	200	3	2	1
200	300	4	2	1
300	400	5	2	2
400	500	6	3	2
500	600	6	3	2
600	700	7	4	2
700	800	8	4	2
800	900	8	5	2
900	1 000	9	5	2
1 000	1 200	10	6	3
1 200	1 400	11	6	3
1 400	1 600 ¹⁾	12	7	3

¹⁾ Rail length > 1 600 mm, please contact Ewellix

Fig. 4

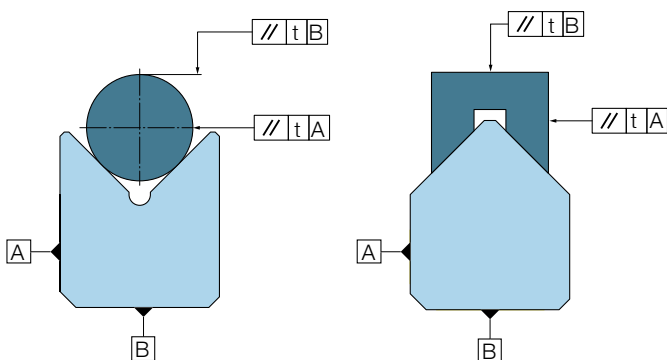

Table 3

Precision of rolling elements

	Ball	Cylinder roller	Needle roller	
Norm	– DIN 5401-1	DIN 5402-1	DIN 5402-3	Not mentioned in DIN
Class	– G10	G1	G2	G1
Roundness	µm 0,25	0,5	1	0,5
Sorting	µm 1	1	2	1
Comment	– Standard	Standard	Standard	Available
Designation in ordering key	– No code	No code	No code	G1

2.1.11 Dimensional accuracy

Ewellix precision rail guides are produced with the following tolerances (→ fig. 5):

- Width A: +0 / -0,3 mm
- Height B: +0 / -0,2 mm
- Centre Height H1 = H2: ± 5 µm¹⁾
- Assembly Height T = H1 + H2: ± 10 µm¹⁾
- Rail length L_{rail}:
- L_{rail} ≤ 300: ± 0,3 mm
- L_{rail} > 300: ± 0,001 mm × L_{rail}

¹⁾ for rail length L_{rail} < 1 000 mm

2.1.12 Grading

For the typical “clamped” arrangement, four precision rails are needed. To reach the best performance in terms of life-time, rigidity and running behaviour, it is important that the centre height of the four rails is within a small tolerance. This is the reason why Ewellix rails are graded and packed together according following rules:

Rails for crossed roller or ball assemblies:

Four rails are matched to each other and packaged as a set.

Rails for needle roller assemblies or slide coatings:

Two M shaped and two V shaped rails are matched and packaged as pairs.

Because of the very close standard tolerance of the centre height, it would also be possible to pair any rail for a standard application (precision class P10) if necessary.

2.1.13 Jointed rails

Jointed rails are available on request and are always graded and well-sorted by Ewellix to ensure smooth running. They are delivered with markings as indicated in fig. 6. For rails composed of two or more sections, the tolerance for the total length is ±2 mm.

Precision rails of series LWRE ACS and LWRE ACSM cannot be jointed.

Fig. 5

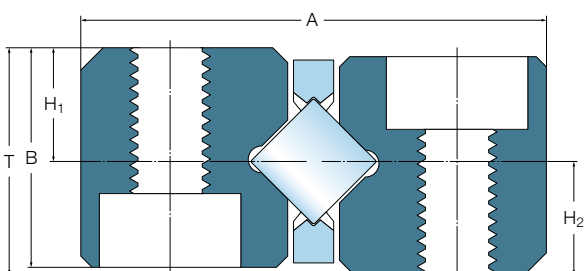

Fig. 6

Marking of jointed rail tracks

	1	1	A
Set number			
Rail track			
Joint			

Set 1

1 - 1A	1 - 1A	1 - 1B	1 - 1B
1 - 2A	1 - 2A	1 - 2B	1 - 2B
1 - 3A	1 - 3A	1 - 3B	1 - 3B
1 - 4A	1 - 4A	1 - 4B	1 - 4B

2.2 Dimensioning of precision rail guide systems

To determine which size of linear guide is the most suitable for your application, we recommend that you make the following calculations:

- Calculation of rating life
- Calculation of static safety factor

These two proven and established calculation methods must consider all loads and forces acting on the precision rail guide system. Representatives of the acting bearing load that describe the whole load case are needed. These representatives must combine all forces, lever arms and torque loads, which can vary by time or stroke. The details and different formulae for the load calculation are explained in **chapter 2.4**. The rating life of a precision rail guide with rolling elements is defined as the total linear distance travelled by the rails before the first sign of material fatigue occurs on one of the raceways and/or the rolling elements. For the selection of rail guides based on rating life calculation (↳ **chapter 2.2.3**), the dynamic load rating C, as defined in **chapter 2.3**, is used. It is expressed as the load that results in a bearing life of 100 km.

2.2.1 The concept of static safety factor calculation

When selecting a precision rail guide, the static safety factor calculation must be considered when one of the following cases arises:

- The guide operates under load at very low speeds.
- The guide operates at normal conditions but must also accept heavy shock loads.
- The guide is loaded stationary for long periods of time.
- The guide is loaded with $P > 50\%$ of the dynamic load rating C where the theory of rating life calculation is not valid any more.

In all such cases, the permissible load is determined not through material fatigue but through the permanent physical deformation at the contact zone of the rolling elements and raceways. Load applied when stationary or at very low operating speeds, as well as heavy shock loads, causes flattening of the rolling elements and results in damage to the raceways. The damage may be uneven or may be spaced along the raceway at intervals corresponding to the rolling element separation. This permanent deformation leads to vibration in the bearing, noisy running and increased friction and may even cause a decrease in preload and, at an advanced stage, an increase in clearance. With continued operation, this permanent deformation may become a starting point for fatigue damage due to resulting peak loads. The seriousness of these phenomena will depend on the particular bearing application.

2.2.2 The method of static safety factor calculation

When determining the bearing size according to static load rating (↳ **chapter 2.3**), one must consider a certain relationship, known as the static safety factor s_0 , between the static load rating C_0 and the maximum static load P_0 . The static safety factor s_0 determines the degree of safety against excessive permanent deformation of the rolling elements and raceways. The static load rating, C_0 , is defined as the static load that would produce a permanent deformation of 0,0001 times the rolling element diameter. Experience shows that, depending on the contact conditions, a maximum Hertzian pressure of 4 000 MPa is permissible at the zone of maximum load without affecting the running qualities of the bearing. See also ISO 14728-2.

Calculation of the static safety factor

For a chosen precision rail guide and a defined load case, the static safety factor s_0 can be calculated as follows:

If maximum load occurs during standstill:

$$s_0 = \frac{C_{0, \text{eff slide}}}{P_0}$$

If maximum load occurs when linear guiding moves:

$$s_0 = \frac{C_{0, \text{eff slide}}}{F_{\text{res max}}}$$

where

- s_0 = static safety factor
- $C_{0, \text{eff slide}}$ = effective static load rating of a slide [N]
- P_0 = maximum static load [N]
- $F_{\text{res max}}$ = maximum resulting load [N]

Depending on the operating conditions, a static safety factor s_0 according to **table 4** is recommended.

If, for example, the precision rail guide system is exposed to external vibrations from machinery in close proximity, higher safety factors should be applied. Moreover, the load transfer paths between a precision rail guide system and its support structure should be taken into account. In particular, the screw connections must be examined for adequate safety. For overhead installations of precision rail guides, higher safety factors should be applied.

NOTE: The general technical rules and standards in the respective industrial sector also must be observed.

Requisite static load rating

For specific operating conditions with a related recommended static safety factor and a defined load case, the requisite static load rating C_0 can be calculated from the following formulae:

If maximum load occurs during standstill:

$$C_{0, \text{eff slide}} = s_0 P_0$$

If maximum load occurs when linear guiding moves:

$$C_{0, \text{eff slide}} = s_0 F_{\text{res max}}$$

where

- $C_{0, \text{eff slide}}$ = effective static load rating of a slide [N]
- P_0 = maximum static load [N]
- s_0 = static safety factor
- $F_{\text{res max}}$ = maximum resulting load [N]

2.2.3 Rating life

In laboratory tests and in practice, it has been found that the rating life of apparently similar bearings under completely identical running conditions can differ. Therefore, calculation of the appropriate bearing size requires a full understanding of the concept of bearing rating life. All references to the dynamic load rating of Ewellix precision rail guides apply to the basic rating life, as covered by the ISO definition (ISO 14728-1), in which the rating life is understood as the life reached or exceeded by 90% of a large group of identical bearings. The majority of the bearings reach a longer rating life, and half the total number of bearings reach at least five times the basic rating life.

Table 4

Static safety factor depending on operating conditions

Operating conditions	s_0
Normal conditions	> 1–2
Smooth, vibration-free operation	> 2–4
Medium vibrations or impact loads	3–5
High vibrations or impact loads	> 5
Overhead installations	The general technical rules and standards in the respective industrial sector must be observed. If the application poses a risk of serious injury, the user must take appropriate design and safety measures that will prevent all rails from becoming detached from the base (e.g. due to loss of rolling elements or failure of screw connections).

2.2.4 Rating life calculation

The rating life of precision rail guides expressed in km, L_{ns} , can be calculated using the following formula:

$$L_{ns} = c_1 100 \left(\frac{C_{eff\ slide}}{P} \right)^p$$

In load cases where the length of travel and stroke frequency is constant, it is often more useful to calculate the rating lives in operating hours L_{nh} using the following formula:

$$L_{nh} = c_1 \frac{5 \cdot 10^7}{S_{sin} n 60} \left(\frac{C_{eff\ slide}}{P} \right)^p$$

where

- L_{ns} = modified basic rating life [km]
- L_{nh} = modified basic rating life [h]
- c_1 = factor for reliability
- $C_{eff\ slide}$ = effective dynamic load rating of a slide [N]
- P = equivalent dynamic load [N]
- p = life exponent; $p = 3$ for balls, $p = 10/3$ for rollers
- n = stroke frequency [double strokes/min]
- S_{sin} = single stroke length [mm]

NOTE: The concept of rating life calculation is only valid in cases where the equivalent dynamic load P does not exceed 50% of the dynamic load rating C . See also the indication for static calculation in **chapter 2.2.1**.

NOTE: The accuracy of the life calculation of a linear guide is enhanced by the correctness of the information about the load case and the known or calculable operating conditions.

NOTE: Lifetime calculation is related to the physical effect of fatigue of material. Fatigue is the result of shear stresses cyclically appearing immediately below the load carrying surface. After a time, these stresses cause cracks that gradually extend up to the surface. As the rolling elements pass over the crack, fragments of material break away. This process is known as flaking or spalling. This flaking progressively increases and eventually makes the bearing inoperable.

Factor c_1 for reliability

Factor c_1 is used in the calculation of bearing life in cases where the intended prediction of reliability has to exceed 90%. The corresponding values for c_1 are given in **table 5**.

Table 5

Factor c_1 for reliability

Reliability %	L_{ns}	c_1
90	L_{10s}	1
95	L_{5s}	0,62
96	L_{4s}	0,53
97	L_{3s}	0,44
98	L_{2s}	0,33
99	L_{1s}	0,21

2.2.5 Service life

In addition to rating life, there also exists the concept of “service life”. This term describes the period of time for which a given linear bearing remains operational in a given set of operating conditions. Therefore, the service life of the bearing depends not necessarily on fatigue but also on

- wear,
- corrosion,
- failure of seals,
- lubrication intervals (grease life),
- misalignment between the shafts,
- vibration during standstill,
- etc.

Normally, the service life can only be quantified in tests under realistic operating conditions or by comparison with similar applications.

2.2.6 Cross reference to related chapters

For the two dimensioning concepts presented in this chapter, static safety factor and basic rating life, the following input data is needed:

- The loads acting on the precision rail guide system. Their calculation is explained in detail in **chapter 2.4**.
- The effective static and dynamic load ratings of a certain precision rail guide system. Their calculation is presented in the **chapter 2.3**.

2.2.7 Dimensioning tool

The dimensioning calculation procedure described in **chapters 2.2 to 2.4** is offered as self-guided, browser-based tool available at www.ewellix.com/en/global/product-selectors/linear-guide-select. This tool will automatically generate a report including calculations, all relevant ordering information, as well as the link to related 3D-CAD files.

2.3 Determination of effective load ratings

For a slide equipped with four precision rails and two rolling element assemblies with an individual number of rolling elements (↳ **fig. 11**), the effective static and dynamic load ratings are calculated as follows:

$$C_{0, \text{eff slide}} = f_{h0} f_t C_{0,10} \frac{2z_T}{10 f_1}$$

$$C_{\text{eff slide}} = f_h f_t C_{10} \left(\frac{2z_T}{10 f_1} \right)^w$$

where

- $C_{0, \text{eff slide}}$ = effective static load rating of a slide [N]
- $C_{0,10}$ = basic static load rating of a rail guide with specified number of rolling elements [N]
- f_{h0} = factor for hardness, static
- f_t = factor for operating temperature
- z_T = number of load carrying rolling elements (per cage or per row for needle rollers)
- f_1 = factor for load direction
- $C_{\text{eff slide}}$ = effective dynamic load rating of a slide [N]
- C_{10} = basic dynamic load rating of a rail guide with specified number of rolling elements [N]
- f_h = factor for hardness, dynamic
- w = rolling element exponent;
 - $w = 0,7$ for balls,
 - $w = 7/9$ for rollers

2.3.1 Static and dynamic load ratings given in the catalogue

The basic load ratings C_{10} and $C_{0,10}$ quoted in the product data tables of rolling element assemblies are defined for one rail guide loaded in the direction shown in **fig. 7** and the following number of rolling elements:

- For 10 balls under load (↳ **fig. 8**)
- For 10 crossed rollers under load (↳ **fig. 9**)
- For 20 needle rollers under load (2 × 10 needle rollers per row) (↳ **fig. 10**)

Fig. 7

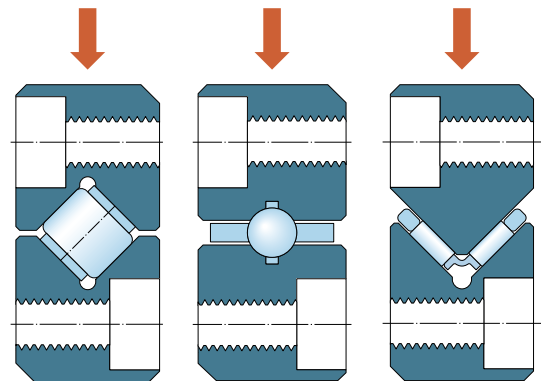

Fig. 8

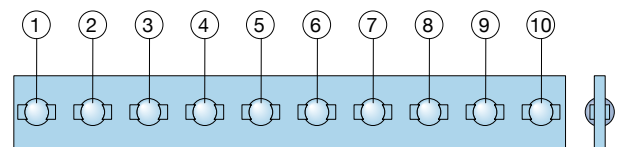

Fig. 9

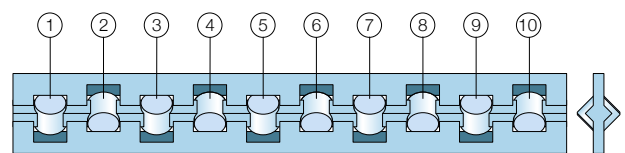
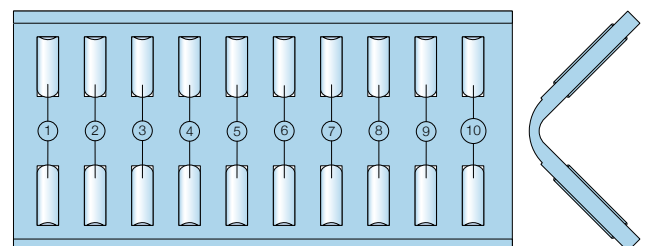

Fig. 10



2.3.2 Influence of hardness

The full load rating of the rolling element assembly can be utilized completely (both factors equal 1) only if the surface hardness of the raceways is at least 58 HRC. If rails of stainless or acid-resistant steel are used and their raceway hardness does not reach the required limit, the values for the factors f_h and f_{h0} can be obtained from **diagram 4**. If rolling elements with a lower hardness, e.g. made from stainless steel, are used, the same factor has to be considered.

NOTE: The static and dynamic load ratings for rolling element assemblies with ACSM, given in the product tables, are reduced already. The corresponding rails are made from stainless steel by standard. For this speciality, it is not useful to additionally utilize the factors $f_{h0} < 1$ and $f_h < 1$.

2.3.3 Influence of operating temperature

When a precision rail guide without plastic cage is permanently used with operating temperatures above +120 °C, the load ratings will decrease by a certain amount. In such cases, the temperature factor f_t has to be taken into consideration. Values of factor f_t can be obtained from **diagram 5** as a function of the operating temperature.



Diagram 4

Factor f_h for the influence of hardness

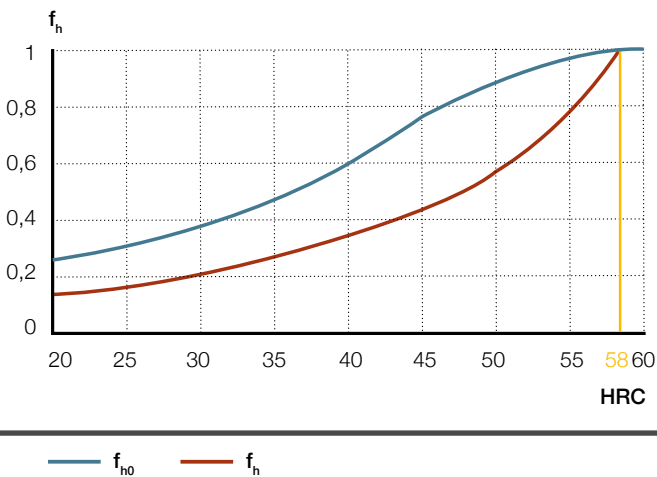
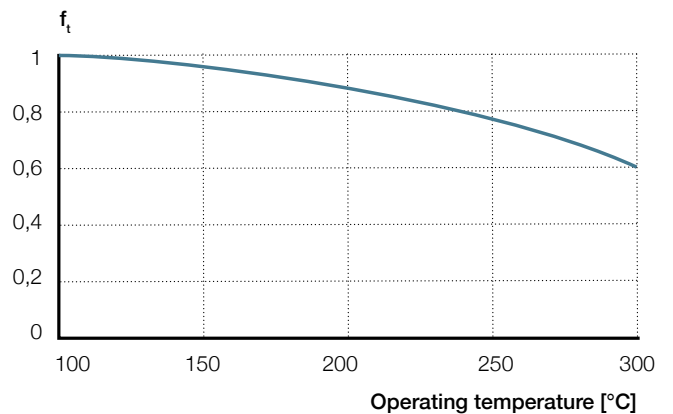

Diagram 5

Factor f_t for the influence of operating temperature



2.3.4 Rail guide arrangements

Precision rail guides can be mounted in several types of arrangements to suit the requirements of the particular application. Two of these are described below. The impact of the two types of arrangements on the load ratings is expressed in factor f_1 for load direction (↳ **fig. 11**).

Clamped arrangement

The most common way to design a precision rail guide system is the clamped arrangement, as it has several advantages:

- The rails can be preloaded to meet demands for rigidity and running accuracy.
- The system can accommodate loads and moments in any direction.
- It has a small cross section for compact construction.

As a rule, rail guide systems in clamped arrangements consist of two identical precision rail guides, as shown in **fig. 11**. With rail guides in such an arrangement, it is even possible to adjust the preload, such as by using set screws, as explained in **chapter 4.1.10**.

Floating arrangement

A rail guide system in a floating arrangement consists of a “locating” bearing e.g. an LWR rail guide, which provides guidance in the longitudinal and lateral directions, and an other rail guide with two flat raceways, which acts as the “non-locating” bearing (↳ **fig. 11**). In such arrangements, care should be taken to ensure that both guide systems have similar load rating and rigidity. Rail guide systems in floating arrangement are able to take up loads that are predominantly vertical only. However, they can support heavy loads and are simple to mount. They can be used to advantage where:

- Thermal expansion must be compensated
- Large distances between supports have to be bridged

Clamped arrangement $f_1 = 2$

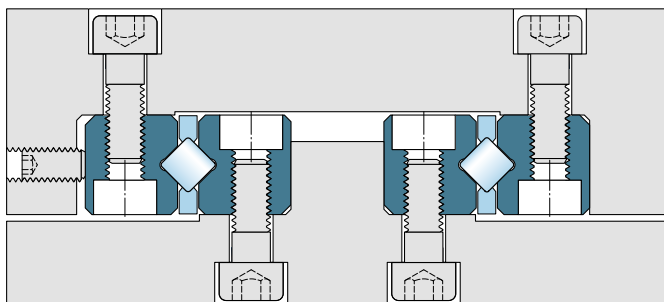

Floating arrangement $f_1 = 1$

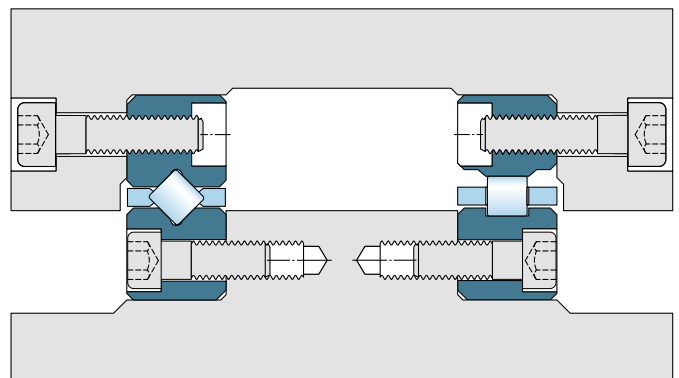

Fig. 11

2.3.5 Rail guide kinematics

Depending on the application and taking into consideration the available space, stroke and environmental conditions, precision rail guide systems can be designed in various ways. Possible kinematics and their individual characteristics are described in the next chapters.

When selecting the dimension of a rail guide and rolling element assembly, the requirements regarding geometry and installation space or the requirements regarding load rating and rigidity are of primary importance. In the first case, the maximum applicable cage length is calculated depending on stroke and length of the rails. The given equations are transformed, if load capacity or rigidity requirements determine the length of the rolling element assembly. In this case, the length of the rails is calculated depending on the length of the cage and stroke.

Not overrunning system without wipers

The rolling element assembly always moves half the distance travelled by the moving rail and remains between the rails (→ fig. 12).

In case the geometry is given

$$L_{cage, max} = L_{rail} - 0,5 S - t_4$$

or the rating life / rigidity defined the length of the rolling element assembly

$$L_{rail, min} = L_{cage} + t_4 + 0,5 S$$

where

$L_{cage, max}$ = maximum length of rolling element assembly, if rail length and stroke are predefined [mm]

L_{rail} = length of the rail [mm]

$L_{rail, min}$ = minimum length of the rail, if length of rolling element assembly and stroke are predefined [mm]

L_{cage} = length of rolling element assembly [mm]

S = intended stroke length [mm]

t_4 = elongation of space for cage by eccentricity of the anti-creeping pinion [mm]

Fig. 12

Kinematic "Not overrunning system without wiper"

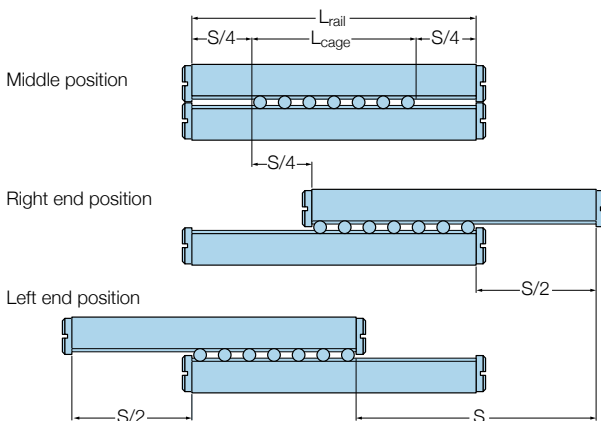

Precision rail guide system with wipers

If the rail guide has to be sealed with wipers, it is important to ensure that the lips of the wipers seal against the raceway of the opposing rail over the whole length of travel. Normally, the rail guide arrangement is fitted with two rails of different lengths. The wipers are attached to the shorter rail, of which the length is determined according to the formulae given above under heading **Not overrunning systems without wipers** (→ fig. 12).

The minimum length of the long rail is (→ fig. 13)

$$L_{rail, long, min} = L_{cage} + t_4 + 1,5 S + 2 L_1$$

or in case the geometry is given

$$L_{cage, max} = L_{rail, long} - 1,5 S - 2 L_1 - t_4$$

where

$L_{rail, long, min}$ = minimum length of the long rail, if length of rolling element assembly and stroke are predefined [mm]

L_{cage} = length of rolling element assembly [mm]

L_1 = thickness of end piece with wiper [mm]

$L_{cage, max}$ = maximum length of rolling element assembly, if rail length and stroke are predefined [mm]

$L_{rail, long}$ = length of the long rail [mm]

S = intended stroke length [mm]

t_4 = elongation of space for cage by eccentricity of the anti-creeping pinion [mm]

Fig. 13

Kinematic "With wiper"

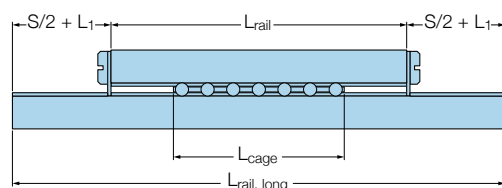

Overrunning system without wipers

If a short precision rail moves on a long rail, overrunning rolling element assemblies should be preferred. It is important that the short rail has lead-in radius at both rail ends (ordered with suffix "EG") so that the overrunning rolling element assembly causes as little pulsation as possible. Not every cage is suitable for this application. The maximum cage overrun ("free length" of the cage) depends on the orientation of the rails and on the cage material.

In case of priority of installation space, the length of the components is calculated as follows (↳ **fig. 14**)

$$L_{\text{cage, max}} = L_{\text{rail, long}} - 0,5 S - t_4$$

and

$$L_{\text{rail, short}} = L_{\text{rail, long}} - S$$

If rigidity or load rating are more important

$$L_{\text{rail, long}} = L_{\text{cage}} + t_4 + 0,5 S$$

and

$$L_{\text{rail, short}} = L_{\text{rail, long}} - S$$

where

$L_{\text{cage, max}}$ = maximum length of rolling element assembly, if rail length and stroke are predefined [mm]

$L_{\text{rail, long}}$ = length of the long rail [mm]

$L_{\text{rail, short}}$ = length of the short rail in an overrunning system [mm]

L_{cage} = length of rolling element assembly [mm]

S = intended stroke length [mm]

t_4 = elongation of space for cage by eccentricity of the anti-creeping pinion [mm]

The exact position of the anti-creeping rack along the rail varies in detail. If 2 rails with anti creeping rack are centralised to each other it could happen

- that 2 teeth of both racks are opposite each other
- that a tooth and a gap of boths racks are opposite each other
- or any situation in between these 2 extrema

To take that eccentricity of the anti-creeping pinion into account, the dimension t_4 is used in the equations for dimensioning of a guiding. For guidings without ACS(x): $t_4 = 0$

Fig. 14

Kinematic "Overrunning system without wipers"

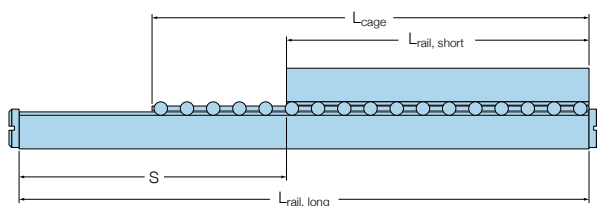

2.3.6 Number of rolling elements z , z_T

After the calculation of the maximum length of the cage $L_{cage, max}$ and the length of the rails according to demanded geometry, the number of rolling elements z has to be calculated for ordering the right length of rolling element assembly. Depending on the different kinematic types the number of load carrying elements z_T has to be defined for the calculation of the rating life. The following overview shows the formulas for z and z_T . For kinematic types, where the rolling element assembly always remains between the rails (not

overrunning rail guide without wipers and rail guide with wipers) and all rolling elements carry load, $z = z_T$ is valid.

In overrunning systems, only the rolling elements underneath the short rail can carry load, and z_T has to be calculated differently.

The formulae use the “truncate” function to arrive at an integer number of rolling elements. With that, the real length of the rolling element assembly for ordering L_{cage} and the load carrying length L_T , defined from the center of the first load carrying rolling element to the center of the last, can be calculated. Additionally the formulas for the installation length $L_{install}$ are given.

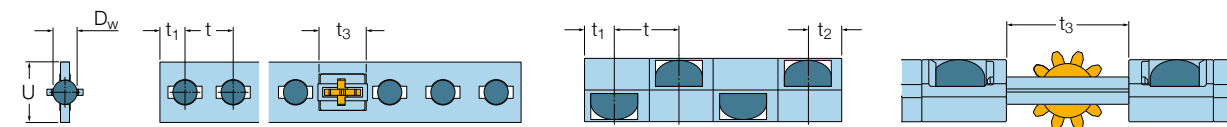
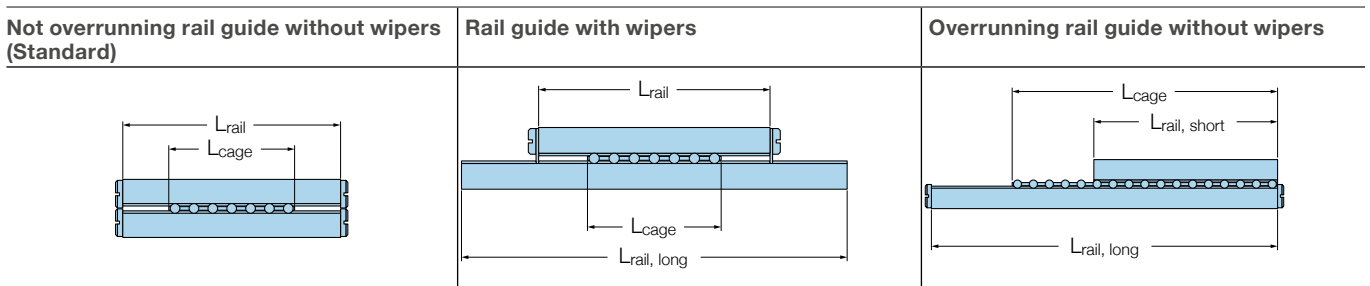

Values for t , t_1 , t_2 and t_3 for the different rolling element assembly types are given in the **chapter Product range 3.1-3.7**.

if no value for t_2 is given: $t_2 = t$
 if no value for t_3 is given: $t_3 = 0$

$$z = \text{TRUNC} \left(\frac{L_{cage, max} - t_1 - t_2 - t_3}{t} \right) + 1$$

$$z_T = \text{TRUNC} \left(\frac{L_{cage, max} - t_1 - t_2 - t_3}{t} \right) + 1$$

$$z_T = \text{TRUNC} \left(\frac{L_{rail, short} - t_3 - 2 EG}{t} \right) + 1$$

$$L_{cage} = (z - 1) t + t_1 + t_2 + t_3$$

$$L_T = (z_T - 1) t + t_3$$

$$L_{install} = L_{rail} + S + 2 L$$

$$L_{install} = L_{rail, long}$$

$$L_{install} = L_{rail, long} + 2 L$$

Legend

z	= number of rolling elements (per cage or per row for needle rollers)
z_T	= number of load carrying rolling elements (per cage or per row for needle rollers)
L_{cage}	= length of rolling element assembly [mm]
$L_{cage, max}$	= maximum length of rolling element assembly [mm]
L_T	= load carrying length [mm]
$L_{rail, short}$	= length of the shorter rail in an overrunning system [mm]
$L_{rail, long}$	= length of the long rail [mm]
t	= pitch of rolling elements in a cage [mm]
t_1, t_2	= distance of outer rolling element to the end of cage [mm]
t_3	= length of anti-creeping system [mm]
EG	= length of lead-in radius on each side, typically 1-2 mm [mm]
$L_{install}$	= length of the complete installation space [mm]
L	= thickness of the end piece [mm]

NOTE: "TRUNC" is the mathematical function that truncates a number to an integer by removing the fractional part of the number.

2.3.7 General geometry of a rail guide system

As a general recommendation, the length of a rolling element assembly can be chosen using the following guidelines:

“clamped” arrangement $L_{\text{cage}} = S$

“floating” arrangement $L_{\text{cage}} = 1,5 S$

where

L_{cage} = length of rolling element assembly [mm]

S = intended stroke length [mm]

It should be remembered, however, that where loads are heavy, applied off-centre, or include torque loads, the longest possible rolling element assembly should be chosen to achieve both an even load distribution and high rigidity.

A further recommendation is that the mean distance between the rolling element assemblies B_1 should not exceed the load-carrying length L_T (→ fig. 15):

$$L_T > B_1$$

where

B_1 = mean distance between the rolling element assemblies [mm]

L_T = load carrying length [mm]

Fig. 15

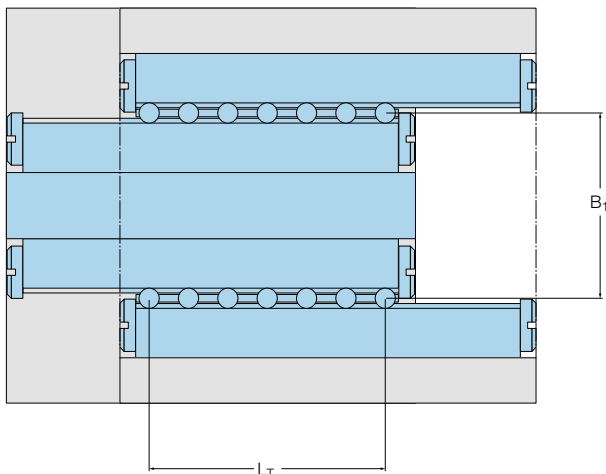

2.4 Calculation of bearing loads

The load can be directly inserted into the rating life equations and the static safety factor equation if the load F acting on a rail guide is constant in magnitude, position and direction and acts vertically and through the centre of the raceway. In all other cases, it is first necessary to calculate the maximum resulting load $F_{res, max}$ and the equivalent dynamic load P . These representative loads are defined as the loads that would have the same influence on the rating life and on the static safety factor s_0 as the real set of loads.

How to deal with loads that do not act vertically and not through the center of the rail guide system is described in **chapter 2.4.1**, and **2.4.3**. How to deal with time- or position-varying loads is explained in **chapter 2.4.5**.

2.4.1 Transfer of external loads to F_y, F_z, M_x, M_y, M_z

First of all, the coordinate system for the selected layout has to be defined. It is preferred to define the moving direction as x-axis. The origin of the coordinate system is set to the middle of the rolling element assembly and all lever arms in x-direction are measured from there. This means that the coordinate system moves and that lever arms change with the movement of the guide (→ **fig. 16**). In the other directions, the origin should be symmetrically between the rolling element assemblies at $B_1/2$ and on the rails centre height (→ **chapter 2.1.11**).

Secondly, all working loads, that have impact on the rail guide system, have to be collected. Load directions and lever arms must not be ignored. The single external loads are summarized to a set of five values: F_y, F_z, M_x, M_y, M_z . These five values are calculated as follows

$$F_y = \sum_{i=1}^u F_{y,i}$$

$$F_z = \sum_{i=1}^u F_{z,i}$$

$$M_x = - \sum_{i=1}^u F_{y,i} z_i + \sum_{i=1}^u F_{z,i} y_i$$

$$M_y = \sum_{i=1}^u F_{x,i} z_i - \sum_{i=1}^u F_{z,i} x_i$$

$$M_z = - \sum_{i=1}^u F_{x,i} y_i + \sum_{i=1}^u F_{y,i} x_i$$

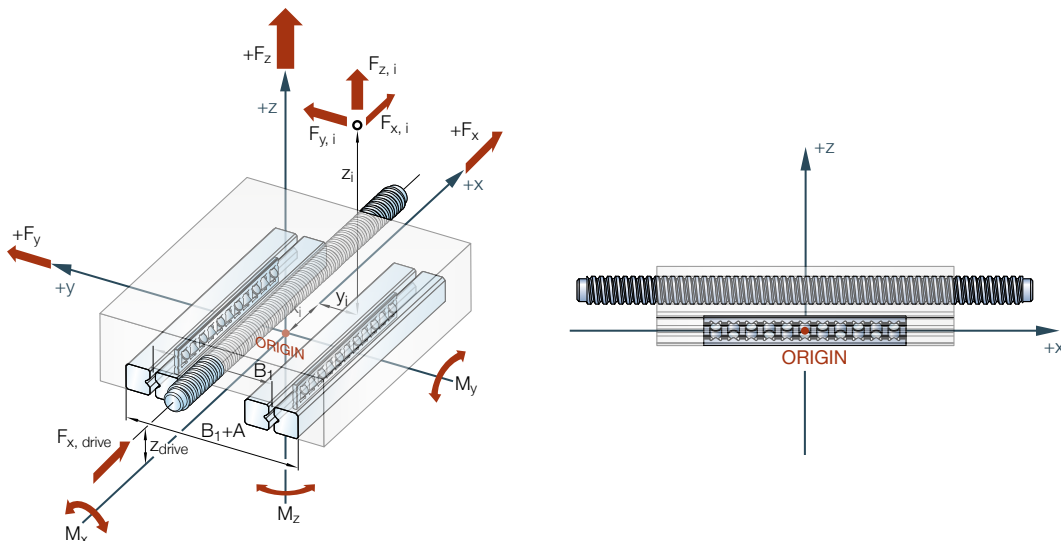

Fig. 16

where

- $F_{x,i}, F_{y,i}, F_{z,i}$ = single loads in x-, y- or z-direction that act simultaneously on the rail guide system [N]
- F_y, F_z = summarized force (load) in y- or z-direction [N]
- M_x, M_y, M_z = summarized torque load in x-, y- or z-direction [Nm]
- x_i, y_i, z_i = lever arms that are related to the single loads [m]
- i = counter for single loads in x-, y- or z-direction that act simultaneously
- U = number of loads that act simultaneously

NOTE: The given set of five values, F_y, F_z, M_x, M_y, M_z are independent of the concrete geometry of the rail guide system.

The precondition for the next calculation steps is that the type and length of rolling element assembly is chosen and the related characteristic values C, C_0 and L_T are defined. Additionally, a value for the mean distance between rolling element assemblies, B_1 , needs to be defined (→ **chapter 2.3.7**).

2.4.2 Preload force

The additional load generated by the preload in a clamped arrangement has to be considered during the dimensioning calculation. The factor for preload, f_{Pr} , depends on the type of rolling element assembly (→ **chapter 4.1.9**). This so-called preload force is calculated using

$$F_{Pr} = C_{eff} f_{Pr}$$

$$C_{eff} = C_{eff\ slide} \quad \text{for clamped arrangement}$$

where

- F_{Pr} = preload force [N]
- C_{eff} = effective dynamic load capacity for one rolling element assembly [N]
- f_{Pr} = factor for preload, %

2.4.3 Transfer of F_y, F_z, M_x, M_y, M_z to one load

The set of five load values F_y, F_z, M_x, M_y, M_z are summed up to the combined bearing load

$$F_{comb} = |F_y| + |F_z| + \left(\left| \frac{2\,000 M_x}{B_1} \right| + \left| \frac{6\,000 M_y}{L_T} \right| + \left| \frac{6\,000 M_z}{L_T} \right| \right)$$

The resulting load F_{res} , which includes the preload force F_{Pr} , is used for the static dimensioning.

$$F_{res} = F_{Pr} + F_{comb} = F_{Pr} + |F_y| + |F_z| + \left(\left| \frac{2\,000 M_x}{B_1} \right| + \left| \frac{6\,000 M_y}{L_T} \right| + \left| \frac{6\,000 M_z}{L_T} \right| \right)$$

The equivalent dynamic load P , which considers the factor for stroke length f_s , is used for dynamic dimensioning.

$$P = f_s F_{res} = f_s \left[F_{Pr} + |F_y| + |F_z| + \left(\left| \frac{2\,000 M_x}{B_1} \right| + \left| \frac{6\,000 M_y}{L_T} \right| + \left| \frac{6\,000 M_z}{L_T} \right| \right) \right]$$

where

- F_{comb} = combined bearing load [N]
- F_{res} = resulting load [N]
- F_{Pr} = preload force [N]
- F_y, F_z = summarized force (load) in y- or z-direction [N]
- M_x, M_y, M_z = summarized torque load in x-, y- or z-direction [Nm]
- B_1 = mean distance between the rolling element assemblies [mm]
- L_T = load carrying length [mm]
- P = equivalent dynamic load [N]
- f_s = factor for stroke length

2.4.4 Influence of stroke length on equivalent dynamic load

When defining the operating conditions for the calculation of the basic rating life, it is assumed that the reference stroke length for the precision rail guide is equal to the length of the rolling element assembly. In precision rail guide applications, however, this rarely applies. Extensive life tests have shown that there is a reduction in the life of a precision rail operated with a short stroke length. This influence of the individual stroke length in relation to the length of the rolling element assembly is shown in **diagram 6**. If there are several load phases with the identical moving direction, a summation of the individual strokes must be done.

$$\sum_{j=A}^B S_j / (L_T - t_3)$$

where

- S_j = individual stroke length [mm]
- j = counter for load phases (A, A+1, A+2, . . . , B)
- A = starting point of movement in one direction
- B = next reversal point
- L_T = load carrying length [mm]
- t_3 = length of anti-creeping system [mm]

NOTE: For ratios greater than 0,6, the reduction in rating life is insignificant, but for lower values, the factor f_s modifies the equivalent dynamic load. In the case of values under 0,1, unfavourable tribological conditions render the calculation of bearing life impractical. Under such conditions, the rating life is determined largely by the sliding conditions in the contact zone.

Diagram 6

Factor f_s for the influence of stroke length

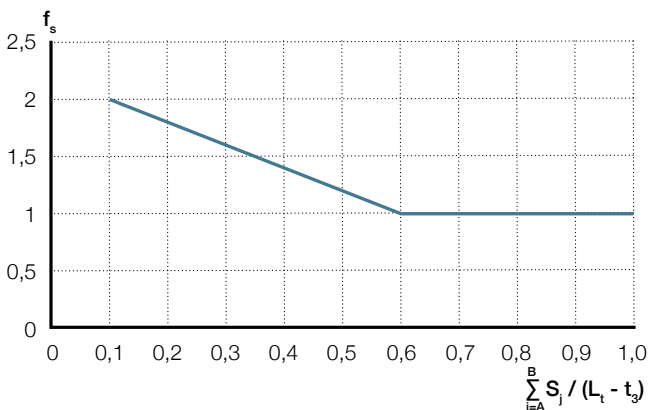

2.4.5 Equivalent dynamic mean load

The rating life calculation formulas assumes that the load and the speed are constant. In reality, the external loads, positions and speeds are changing in most cases and the workflow has to be separated into load phases with constant or approximately constant conditions along their individual strokes. Since the lever arms in x-direction are changing with the movement of the guide, the equivalent dynamic load is varying continuously and for calculations without electronic devices simplifications have to be made (→ **diagram 7**). All single load phases are summarized to the equivalent dynamic mean load P_m depending on their individual stroke length:

$$P_m = \sqrt[p]{\frac{\sum_{j=1}^V |P_j|^p S_j}{S_{tot}}}$$

$$S_{tot} = S_1 + S_2 + S_3 + \dots + S_V$$

where

- P_m = equivalent dynamic mean load [N]
- P = equivalent dynamic load [N]
- p = life exponent;
 - p = 3 for balls,
 - p = 10/3 for rollers
- j = counter for load phases
- V = number of load phases
- S_j = individual stroke length [mm]
- S_{tot} = total stroke length [mm]

Diagram 7

Variable load on a precision rail guide

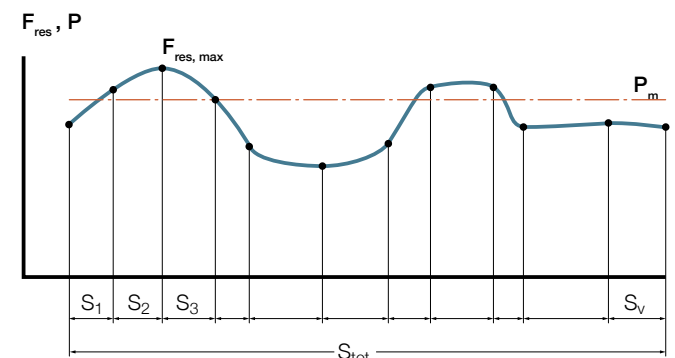

2.4.6 Maximum resulting load

If the maximum load occurs when linear guiding moves, the maximum value of F_{res} is required for calculating the static safety factor s_0 . To this end, all loads must be calculated for the individual stroke lengths. With these figures, the maximum resulting load $F_{res, max}$ can be calculated and then applied in the equation for s_0 .

$$F_{res, max} = \text{MAX}_{j=1}^v |F_{res, j}|$$

$$F_{res, max} = \text{MAX}_{j=1}^v \left[F_{Pr} + |F_{y,j}| + |F_{z,j}| + \left(\left| \frac{2\,000 M_{x,j}}{B_1} \right| + \left| \frac{6\,000 M_{y,j}}{L_T} \right| + \left| \frac{6\,000 M_{z,j}}{L_T} \right| \right) \right]$$

P_0 , the maximum static load during standstill, is calculated by similar formula. The maximum of the values P_0 and $F_{res, max}$ has to be inserted in the formula for static safety factor s_0 .

2.4.7 Elaborated equation for the static safety factor

All given equations related to the static safety factor can be integrated into one formula:

$$s_0 = \frac{C_{0, eff slide}}{F_{res, max}} = \frac{f_h f_t C_{0,10} \frac{2z_T}{10 f_1}}{\text{MAX}_{j=1}^v \left[F_{Pr} + |F_{y,j}| + |F_{z,j}| + \left(\left| \frac{2\,000 M_{x,j}}{B_1} \right| + \left| \frac{6\,000 M_{y,j}}{L_T} \right| + \left| \frac{6\,000 M_{z,j}}{L_T} \right| \right) \right]} \quad \text{or} \quad s_0 = \frac{C_{0, eff slide}}{P_0}$$

2.4.8 Elaborated equation for the rating life

All given equations related to the rating life calculation can be integrated into one formula:

$$L_{ns} = c_1 100 \left(\frac{C_{eff slide}}{P} \right)^p = c_1 100 \frac{f_h f_t C_{10} \left(\frac{2z_T}{10 f_1} \right)^w}{\sqrt[p]{\frac{\sum_{j=1}^v |P_j|^p S_j}{S_{tot}}}}$$

$$L_{ns} = c_1 100 \frac{f_h f_t C_{10} \left(\frac{2z_T}{10 f_1} \right)^w}{\sqrt[p]{\frac{\sum_{j=1}^v |f_{s,j}|^p \left[F_{Pr} + |F_{y,j}| + |F_{z,j}| + \left(\left| \frac{2\,000 M_{x,j}}{B_1} \right| + \left| \frac{6\,000 M_{y,j}}{L_T} \right| + \left| \frac{6\,000 M_{z,j}}{L_T} \right| \right) \right]^p S_j}{S_{tot}}}}$$

$$L_{ns} = c_1 100 \frac{f_h f_t C_{10} \left(\frac{2z_T}{10 f_1} \right)^w S_{tot}}{\sum_{j=1}^v |f_{s,j}|^p \left[F_{Pr} + |F_{y,j}| + |F_{z,j}| + \left(\left| \frac{2\,000 M_{x,j}}{B_1} \right| + \left| \frac{6\,000 M_{y,j}}{L_T} \right| + \left| \frac{6\,000 M_{z,j}}{L_T} \right| \right) \right]^p S_j}$$

2.5 Example dimensioning calculation

The customized Ewellix precision rail guide slide used for this example is equipped with an ironless linear motor with high velocity constancy as drive, with a sealed optical encoder and with mechanical end stops. The shown design is typical of precision rail guide slides (→ fig. 17).

Application description

A construction part (mass 40 kg, length 150 mm, width 100 mm, height 90 mm) has to be moved in several process steps to perform a measurement. The first step is a very precise movement over its entire length. The measurement can be performed at a maximum acceleration of 1 m/s^2 and is running at constant room temperature of $22 \text{ }^\circ\text{C}$. The next process step, which is done at standstill, creates a load of 600 N downward in z-direction located symmetrically between the precision rail guide units and in x-direction 20 mm

inside the construction part. The available construction space limits L_{rail} to 250 mm. To have a certain reserve, the intended stroke of the slide is 160 mm. For forward and backward stroke the values for acceleration and deceleration are equal. Because of the high demands on repeatability of running accuracy in height and sideward direction, an anti-creeping system is required. So the precision rail guides with ACSM have to be used.

Questions to be answered:

- Which precision rail guide (size, L_{cage}) is sufficient for this application?
- Which maximum stroke will be possible?
- Which static safety factor and rating life in kilometers can be achieved?

Fig. 17

RLM with coordinate system

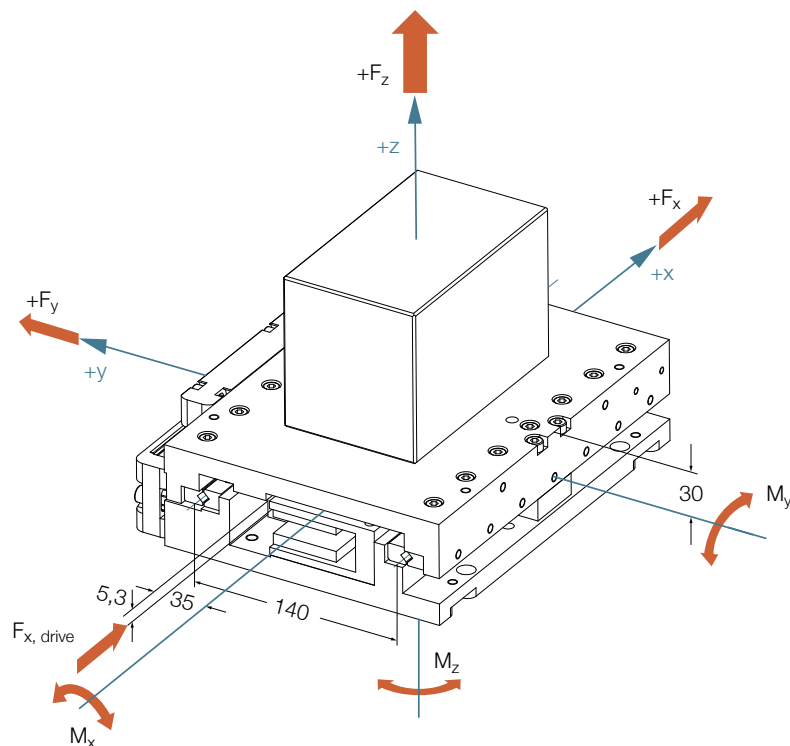

Maximum length of rolling element assembly

In this example the geometry is given by the construction space and the demanded stroke. According to **chapter 2.4.5**, the following formula has to be used:

$$\begin{aligned} L_{\text{cage, max}} &= L_{\text{rail}} - 0,5 S \\ L_{\text{cage, max}} &= 250 \text{ mm} - 0,5 \times 160 \text{ mm} \\ &= 170 \text{ mm} \end{aligned}$$

Number of rolling elements z, z_T

Because of the chosen kinematic – not overrunning cage without wipers –, all rolling elements are permanently loaded and $z = z_T$. To calculate a real value of z, a certain type and size of rolling element assembly has to be chosen. Because of the fact that mass and external load are relatively light in this example we start the calculation with the smallest possible rolling element assembly type LWJK 2 ACSM which may fulfill the requirements. When checking the maximum rail length of LWRB2 we find out that 200 mm do not cover the needs and LWRE 3 ACSM is the smallest guiding possible. The following formula has to be used, as described in **chapter 2.3.6**. The needed values are given in the relevant product chapter.

$$\begin{aligned} z = z_T &= \text{TRUNC} \left(\frac{L_{\text{cage, max}} - t_1 - t_2 - t_3}{t} \right) + 1 \\ z = z_T &= \text{TRUNC} \left(\frac{170 \text{ mm} - 2,65 \text{ mm} - 3,6 \text{ mm} - 9 \text{ mm}}{6,25 \text{ mm}} \right) + 1 = 25 \end{aligned}$$

The number of rolling elements is used to calculate L_{cage} needed for ordering:

$$\begin{aligned} L_{\text{cage}} &= (z - 1) t + t_1 + t_2 + t_3 \\ L_{\text{cage}} &= (25 - 1) \times 6,25 \text{ mm} + 2,65 \text{ mm} \\ &\quad + 3,6 \text{ mm} + 9 \text{ mm} = 165,25 \text{ mm} \end{aligned}$$

The number of rolling elements is used to calculate the load carrying length L_T :

$$\begin{aligned} L_T &= (z_T - 1) t + t_3 \\ L_T &= (25 - 1) \times 6,25 \text{ mm} + 9 \text{ mm} = 159 \text{ mm} \end{aligned}$$

With the exact length of the rolling element assembly, the resulting maximum stroke can be calculated.

$$\begin{aligned} S &= (L_{\text{rail}} - L_{\text{cage}}) \cdot 2 \\ S &= (250 \text{ mm} - 165,25 \text{ mm}) \times 2 = 169,5 \text{ mm} \end{aligned}$$

The general rules $L_{\text{cage}} = S$ for “clamped” arrangement and $L_T > B_1$ are observed.

Determination of effective load ratings

For the calculation of the static safety factor and the rating life, the effective load ratings must be known. It is important to know several determining factors as shown in **table 6**. Furthermore the values of $C_{0,10}$ and C_{10} of the selected rolling element assembly have to be gathered in the product chapter.

$$\begin{aligned} C_{0, \text{eff slide}} &= f_{h0} f_t C_{0,10} \frac{2z_T}{10 f_1} \\ C_{0, \text{eff slide}} &= 1 \times 1 \times 8160 \text{ N} \times \frac{2 \times 25}{10 \times 2} = 20400 \text{ N} \\ C_{\text{eff slide}} &= f_h f_t C_{10} \left(\frac{2z_T}{10 f_1} \right)^w \\ C_{\text{eff slide}} &= 1 \times 1 \times 5040 \text{ N} \left(\frac{2 \times 25}{10 \times 2} \right)^{\frac{7}{9}} = 10279 \text{ N} \end{aligned}$$

Table 6

Description	Value	Reasons for decision
f_{h0}	1	Compare chapter 2.4.2
f_h	1	Compare chapter 2.4.2
f_t	1	Operating temperature far below 120 °C
f_1	2	Clamped arrangement
w	7/9	Crossed roller assembly
$C_{0,10}$	8160 N	LWAKE 3 ACSM
C_{10}	5040 N	LWAKE 3 ACSM

Calculation of bearing loads

In addition to the effective load ratings it is also necessary to calculate the maximum resulting load $F_{res, max}$ and the equivalent dynamic mean load P_m of the application. For that, it is essential to understand the workflow of the application and where and at what time the loads are acting. In most cases it is necessary to separate the workflow into load phases with constant or nearly constant conditions.

The definition of the general coordinate system is shown in **fig. 17, page 31** at the beginning of this chapter. **Fig. 18** shows the lever arms in x-direction of load phase 6 of the example. For an explanation, where to set the coordinate system, see also **chapter 2.4**.

For each load phase the working loads have to be summarized to a set of five values: F_y, F_z, M_x, M_y, M_z . After that, those five values and the preload force are transferred to one load which represents the respective load phase. The workflow of the application with its single load phases and the acting loads including their lever arms of the example are shown in following systematic overview (↳ **table Load calculation, page 34 and 35**). Also the necessary formulae and calculations can be found there. Since the values for acceleration and deceleration are equal on forward and backward stroke, it is here sufficient to calculate P_m only with the load phases of the forward stroke.

The factor for stroke length has to be determined with the help of **diagram 6, chapter 2.4.4**.

$$\frac{S}{L_{cage}} = \frac{150 \text{ mm}}{165,25 \text{ mm}} = 0,91 \quad f_s = 1$$

The preload force has to be calculated. The factor for preload f_{Pr} depends on the type of rolling element assembly (↳ **chapter 4.1.10**).

$$F_{Pr} = f_{Pr} C_{eff \text{ slide}}$$

$$F_{Pr} = 0,07 \times 10 \text{ 279 N} = 719,5 \text{ N}$$

Maximum resulting load

The maximum resulting load occurs in load phase 6.

$$F_{res, max} = \text{MAX}_{j=1}^V |F_{res, j}|$$

$$F_{res, max} = 4 \text{ 362 N}$$

Calculation of the static safety factor

Now for the chosen precision rail guide and the load phase with the highest resulting load, the static safety factor s_0 can be calculated.

$$s_0 = \frac{C_{0, eff \text{ slid}}}{F_{res, max}}$$

$$s_0 = \frac{20 \text{ 400 N}}{4 \text{ 362 N}} = 4,68$$

Equivalent dynamic mean load

For the calculation of the rating life the equivalent dynamic mean load is needed. The single values, the needed formula and the calculations are given in **table Load calculations, page 34 and 35**.

The result is

$$P_m = \sqrt[p]{\frac{\sum_{j=1}^V |P_j^p| S_j}{S_{tot}}} = 1 \text{ 489 N}$$

Rating life calculation

The rating life of precision rail guides expressed in km, L_{ns} , can now be calculated using the following formula:

$$L_{ns} = c_1 \text{ 100 km} \frac{C_{eff \text{ slide}}}{P_m}$$

$$L_{10s} = 1 \times 100 \text{ km} \times \frac{10 \text{ 279 N}}{1 \text{ 489 N}}^{\frac{10}{3}} = 62 \text{ 640 km}$$

Fig. 18

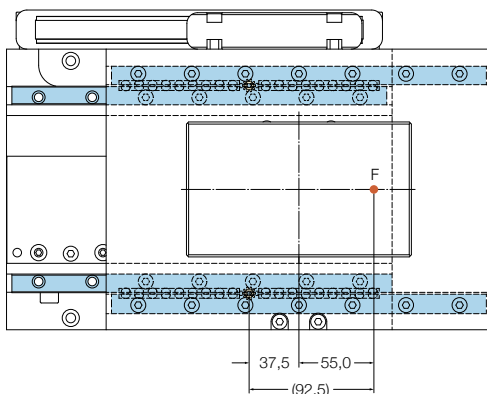

Load calculations

Workflow divided in load phases	Load phase 1			Load phase 2		
	Acceleration, starting from left position			Constant speed		
Individual stroke length Sj:	5 mm			40 mm		
Acceleration:	1 m/s ²			0 m/s ²		
Speed:	Increasing			0,1 m/s		
Position at beginning of load phase:	-75 mm			-70 mm		
Comment: Forces in Newtons [N] Lever arms in Meters [m] Torque loads in Newtonmeters [Nm]				Lever arm is decreasing. As assumption the worst case is chosen for the whole load phase.		
	Lever arms			Lever arms		
	x	y	z	x		
Name of force in x-direction	Force F _x			Force F _x		
Driving force	40	0,035	-0,0053			
Inertia force	-40	0	0,075			
Name of force in z-direction	Force F _z			Force F _z		
Construction part	-392,4	-0,0375	0	-392,4	-0,035	
Additional load						
$F_y = \sum_{i=1}^u F_{y,i}$	0			0		
$F_z = \sum_{i=1}^u F_{z,i}$	-392,4			-392,4		
$M_x = - \sum_{i=1}^u F_{y,i} z_i + \sum_{i=1}^u F_{z,i} y_i$	0			0		
$M_y = \sum_{i=1}^u F_{x,i} z_i - \sum_{i=1}^u F_{z,i} x_i$	-17,93			-13,73		
$M_z = - \sum_{i=1}^u F_{x,i} y_i + \sum_{i=1}^u F_{y,i} x_i$	-1,4			0		
$F_{res} = F_{Pr} + F_y + F_z + \left(\left \frac{2\,000\,M_x}{B_1} \right + \left \frac{6\,000\,M_y}{L_T} \right + \left \frac{6\,000\,M_z}{L_T} \right \right)$	1 841,3			1 630,0		
$P = f_s F_{res} = f_s \left(F_{Pr} + F_y + F_z + \left(\left \frac{2\,000\,M_x}{B_1} \right + \left \frac{6\,000\,M_y}{L_T} \right + \left \frac{6\,000\,M_z}{L_T} \right \right) \right)$	1 841,3			1 630,0		
$P_m = \sqrt[3]{\frac{\sum_{j=1}^v P_j^p S_j}{S_{tot}}}$						

Load phase 3 Constant speed		Load phase 4 Constant speed		Load phase 5 Deceleration			Load phase 6 Right position at standstill with load		
60 mm		40 mm		5 mm			0 mm		
0 m/s ²		0 m/s ²		-1 m/s ²			0 m/s ²		
0,1 m/s		0,1 m/s		Decreasing			0 m/s		
0 mm		70 mm		70 mm			75 mm		
Lever arm is decreasing, becomes zero and is increasing. As assumption the lever arm is set to zero for the whole load phase.		Lever arm is increasing. As assumption the lever arm from the end of this load phase is chosen (worst case).							
Lever arms		Lever arms		Lever arms			Lever arms		
x		x		x y z			x y z		
Force F _x		Force F _x		Force F _x			Force F _x		
				-40	0,035	-0,0053			
				40	0	0,075			
Force F _z		Force F _z		Force F _z			Force F _z		
-392,4	0	-392,4	0,035	-392,4	0,035	0	-392,4	0,0375	0
							-600	0,0925	0
0		0		0			0		
-392,4		-392,4		-392,4			-992,4		
0		0		0			0		
0		13,73		16,95			70,22		
0		0		1,4			0		
1 111,9		1 630,0		1 804,4			4 361,7		
1 111,9		1 630,0		1 804,4			4 361,7		

$$P_m = 10^3 \sqrt{\frac{1841,3 \text{ N}^{10/3} \times 5 \text{ mm} + 1630 \text{ N}^{10/3} \times 40 \text{ mm} + 1111,9 \text{ N}^{10/3} \times 60 \text{ mm} + 1630 \text{ N}^{10/3} \times 40 \text{ mm} + 1804,4 \text{ N}^{10/3} \times 5 \text{ mm}}{5 \text{ mm} + 40 \text{ mm} + 60 \text{ mm} + 40 \text{ mm} + 5 \text{ mm}}} = 1 489 \text{ N}$$

2.6 Rigidity calculation

For the user of precision rail guide systems it is of particular importance to be able to calculate the elastic deflection of the arrangement at the point where the load is applied. To arrive at an approximation of this figure, it is first of all necessary to determine the elastic deformation caused by the rolling elements on the raceway δ , by using one of the **diagrams 8–11**. This value has to be multiplied with factor f_k , to achieve an approximate value for the resulting deflection δ_{res} , that a precision rail guide system, including the adjacent parts made of steel, will have. The following two chapters describe this procedure.

- Diagram 8:** LWR rail guides with crossed roller assembly
- Diagram 9:** LWR rail guides with ball assembly
- Diagram 10:** LWRE rail guides with crossed roller assembly
- Diagram 11:** LWRM/LWRV and LWM/LWV rail guides with needle roller assembly

There is a calculation example in **chapter 2.6.3**, for which **diagrams 8** and **10** already contain the values and lines.

2.6.1 Determination of elastic deformation using the nomogram

When using a nomogram from **diagrams 8–11** it is first of all necessary to establish the load conditions in relation to the mechanical dimensions and to define for which load phase and dominating single load in z-direction the elastic deformation should be calculated. **Fig. 19** shows the necessary parameters required for the calculation.

The rolling element diameter D_w and the contact length of rolling element $L_{w\text{eff}}$ can be obtained from **table 7**. After these calculations the elastic deformation for the point where the load is applied can be read off the nomogram. The nomograms are based on "clamped" rail guides (→ **chapter 2.3.4**) and relate as follows to the various types of precision rail guides.

Table 7

Contact length

Rolling element assembly	Diameter of rolling element	Contact length of rolling element	Product series
–	D_w mm	$L_{w\text{eff}}$ mm	
LWJK 1,588	1,588	–	LWR
LWJK 2	2	–	
LWAK 3	3	1,1	
LWAL 6	6	2,4	
LWAL 9	9	3,6	
LWAL 12	12	5,4	LWRE
LWAKE 3	4	2,3	
LWAKE 4	6,5	3,2	
LWAKE 6	8	4,7	
LWAKE 9	12	8,2	LWRM/V LWM/V
LWHV 10	2	4,4	
LWHW 10	2	4,4	
LWHV 15	2	7,4	
LWHW 15	2	6,4	
LWHV 20	2,5	11,4	
LWHW 20	2,5	9,4	
LWHW 25	3	13,4	
LWHW 30	3,5	17,4	

Fig. 19

Leverage ratio 1

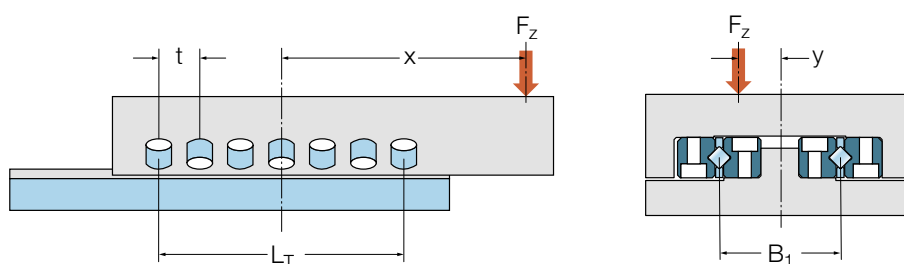

Preparation

Determination of number of load carrying rolling elements as control parameter for the nomograms:

Crossed roller assembly:

$$z_{\text{Tnomo}} = 2 \left(\frac{L_T}{t} + 1 \right)$$

Ball and needle roller assembly:

$$z_{\text{Tnomo}} = \frac{L_T}{t} + 1$$

Calculation of average rolling element load for:

Crossed roller assembly:

$$Q = \frac{2 F_z}{z_{\text{Tnomo}}}$$

Ball and needle roller assembly:

$$Q = \frac{F_z}{2 z_{\text{Tnomo}}}$$

Calculation of the leverage ratio R_x :

$$R_x = \frac{x}{t}$$

Calculation of the leverage ratio R_y :

$$R_y = \frac{y}{B_1}$$

where

z_{Tnomo} = number of rolling elements as control parameter for the nomogram

L_T = load carrying length [mm]

t = pitch of rolling elements in cage [mm]

Q = average load per rolling element [N]

F_z = single load in z-direction [N]

x = distance from centre of rolling element assembly to point of application of load [mm]

y = distance from centre of rail guide unit to point of application of load [mm]

B_1 = mean distance between the rolling element assemblies [mm]

D_w = rolling element diameter [mm]

$L_{w \text{ eff}}$ = contact length of rolling element [mm]

Identify the elastic deformation in the nomogram

The values calculated according to the section "Preparation" are now needed to finally identify the elastic deformation δ in the nomogram (↳ **diagram 8-11**).

Diagram 8

Nomogram of elastic deformation for LWR rail guides with crossed roller assembly

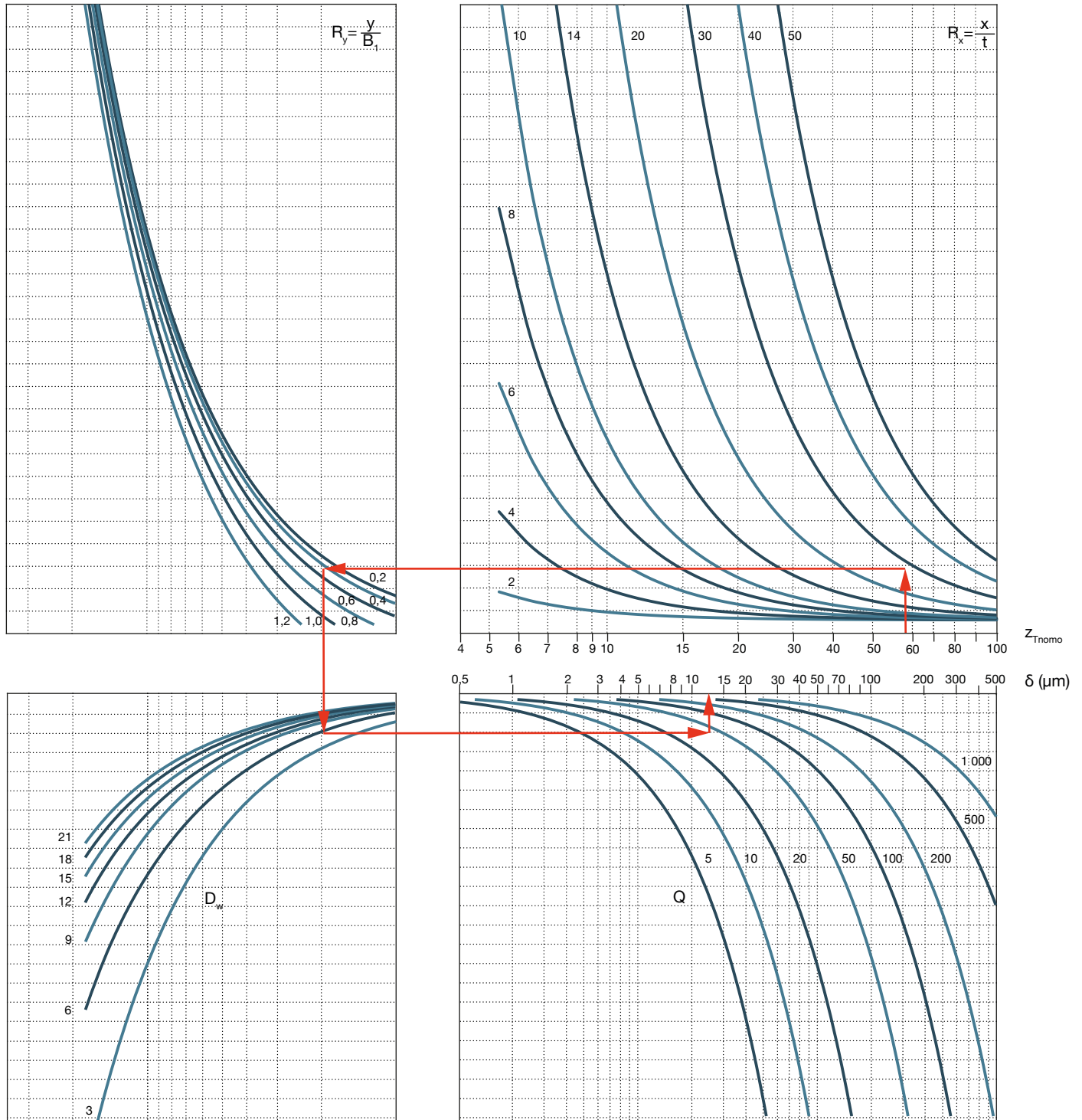

Diagram 9

Nomogram of elastic deformation for LWR rail guides with ball assembly

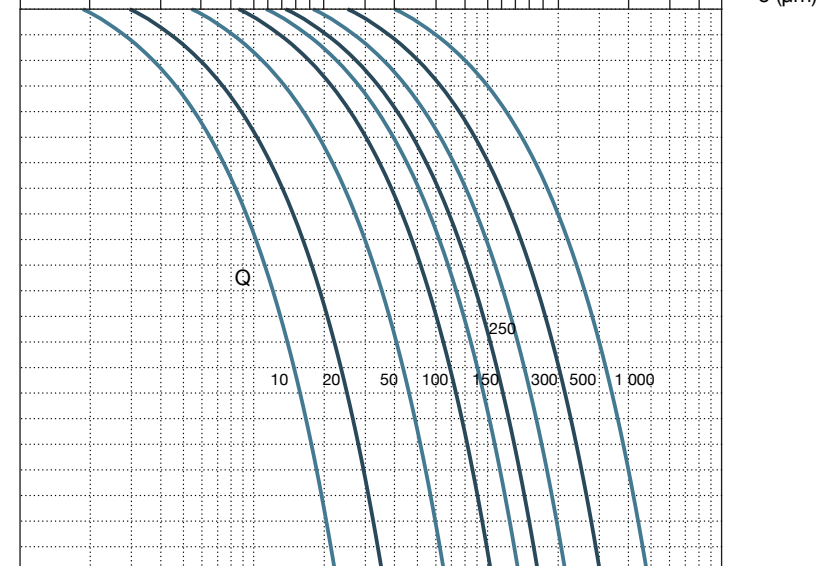
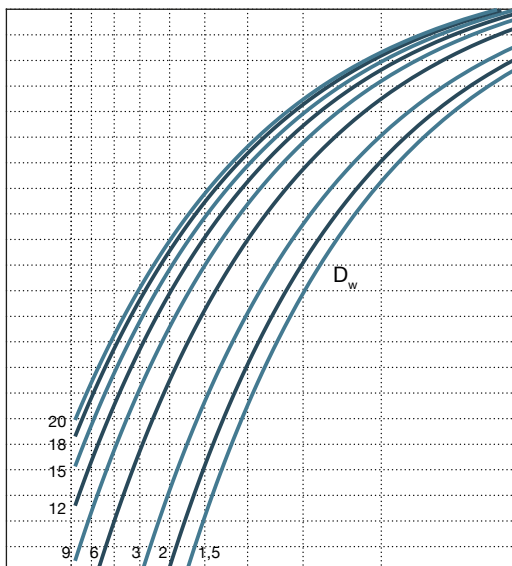
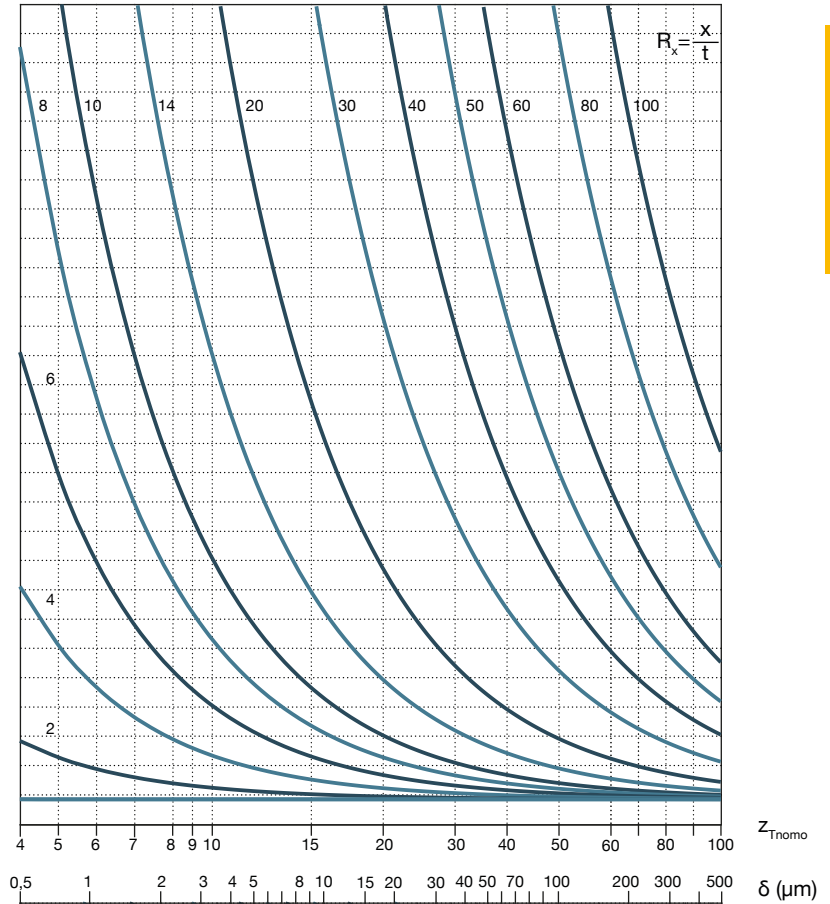
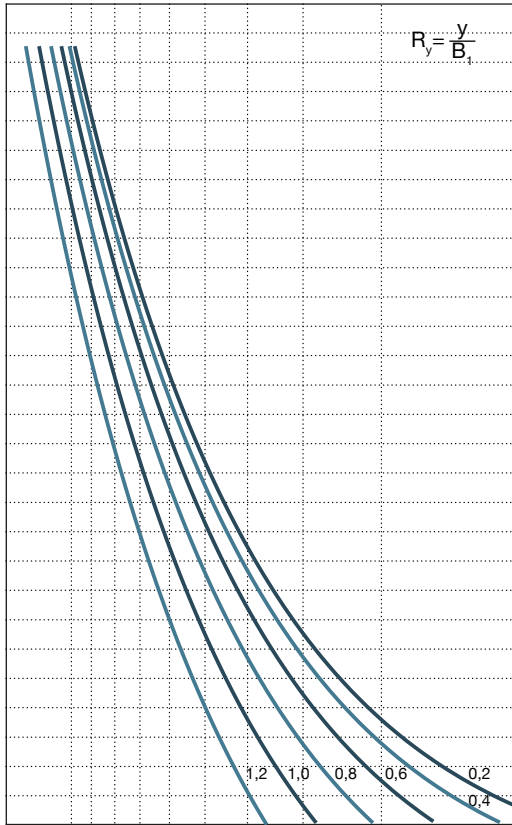

Diagram 10

Nomogram of elastic deformation for LWRE rail guides with high-capacity crossed roller assembly

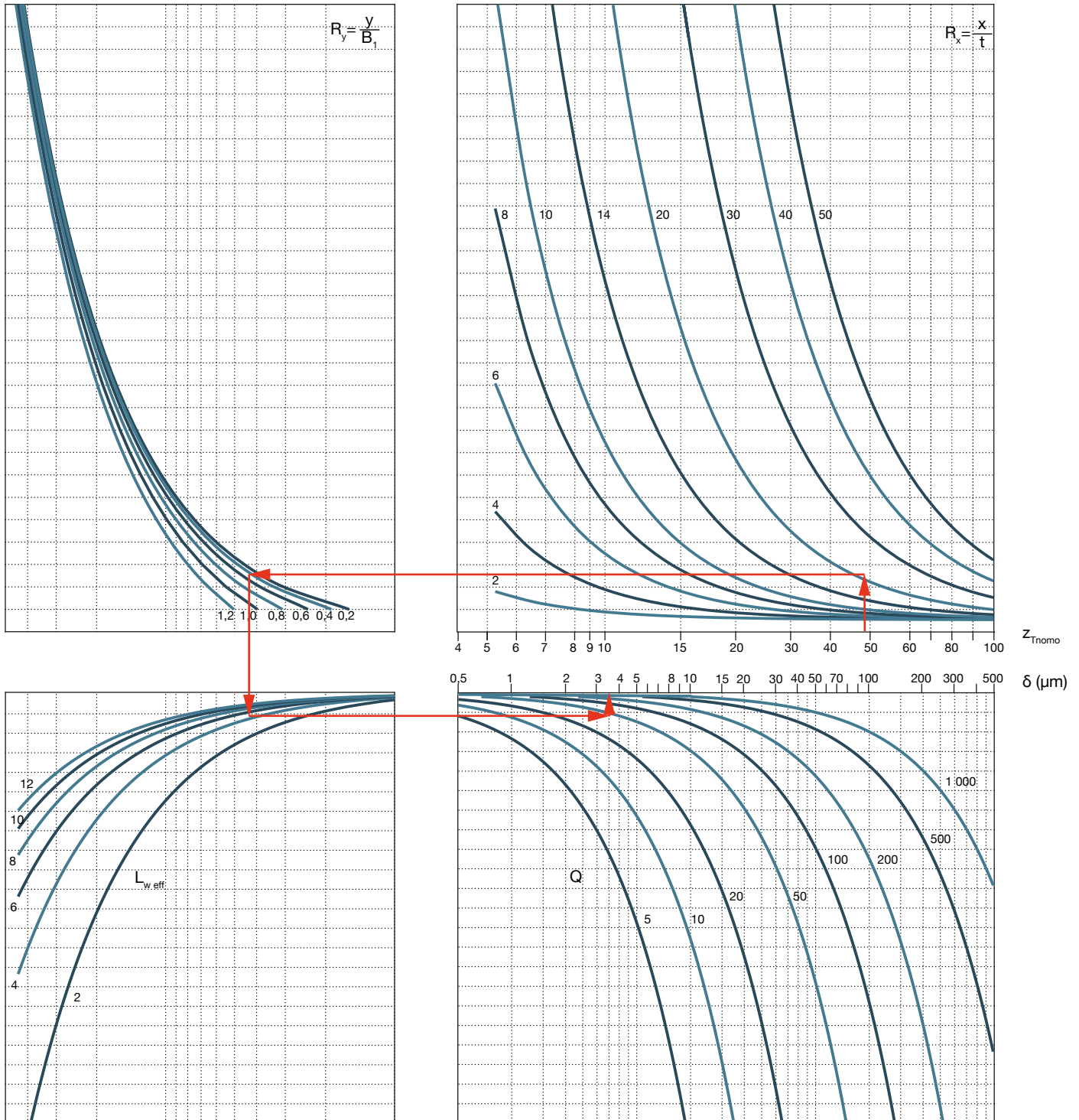
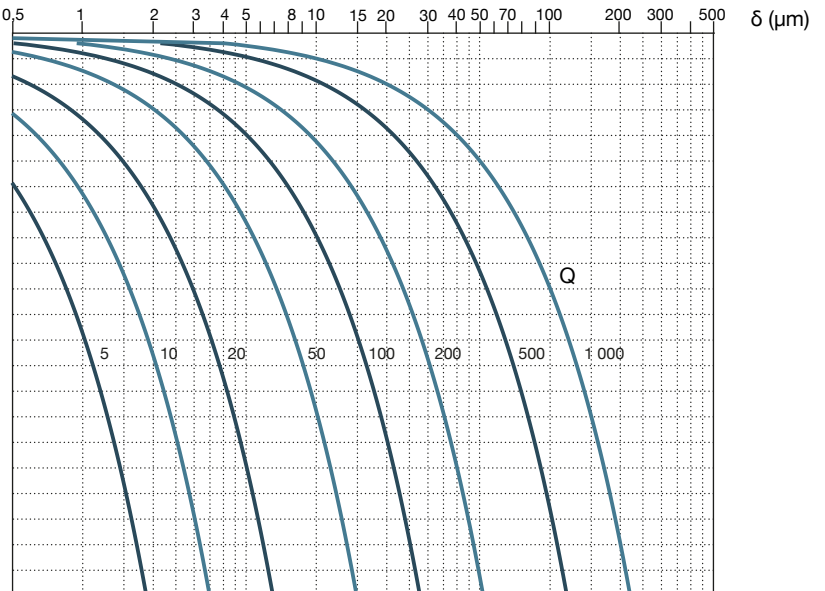
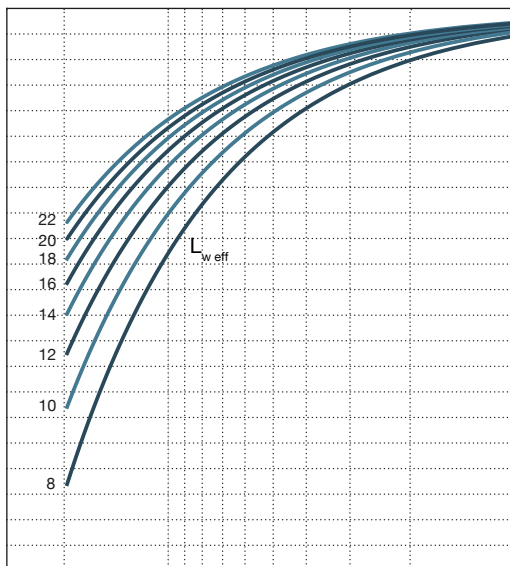
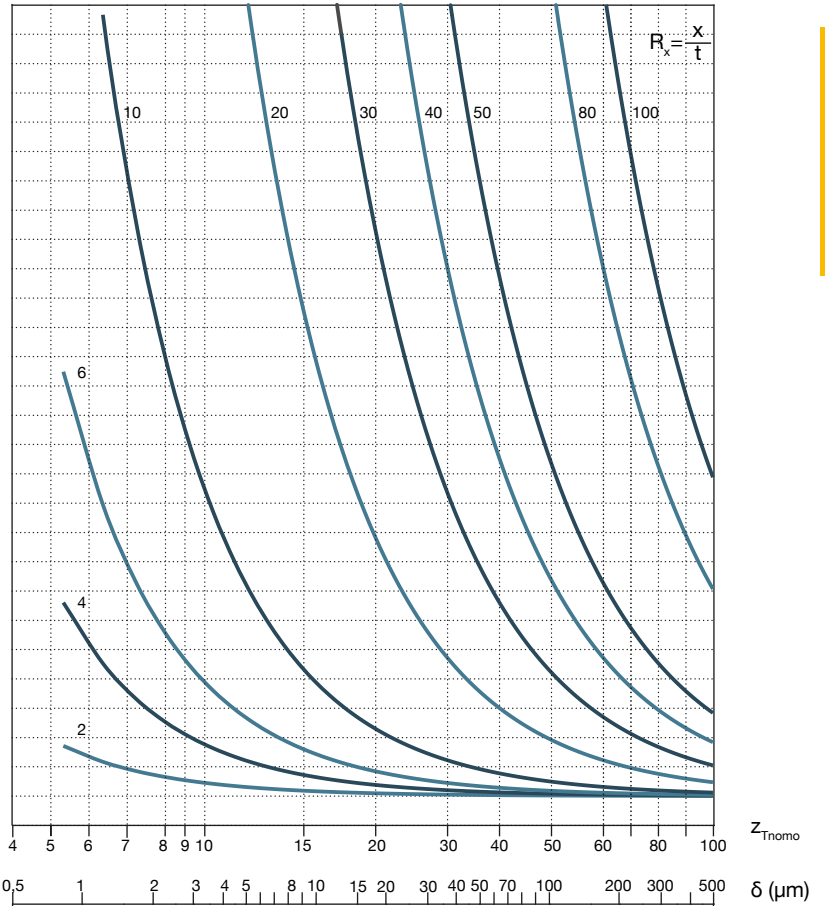
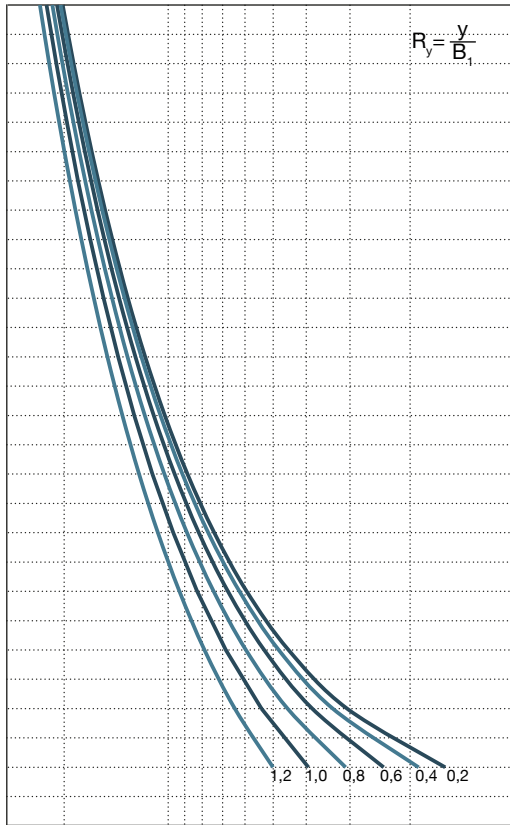

Diagram 11

Nomogram of elastic deformation for LWRM / LWRV and LWM / LWV rail guides with needle roller assembly



2.6.2 Determination of resulting deflection of a rail guide system

When comparing the measured elastic deflection of a complete slide system with the values from the nomograms, it can be seen that the rigidity of the complete slide system is significantly lower. This discrepancy is mainly due to uneven load distribution along the guide. This happens because inaccuracies of form, deviation from parallelism, improper mounting, etc. and can lead to variations in the loading of the single rolling element along the rail guide. By using factor f_k , which is based on control parameter z_{Tnomo} and the specific load on a rolling element k , attention is paid to these circumstances. The relevant values of f_k for LWRE rail guides with crossed roller assembly and LWRM/LWRV rail guides or LWM/LWV rail guides with needle roller assembly can be obtained from **diagram 12**. When calculating the elastic deflection of an LWR rail guide, the correction factor f_k has to be obtained from **diagram 13**. When using LWR rail guides with ball assembly the calculated values conform to the measurements and no factor f_k is needed.

For the calculation example in **chapter 2.6.3**, both diagrams already contain the values and lines.

Determination of the specific load per rolling element:
for LWR crossed roller assembly:

$$k = \frac{2 F_z}{z_{Tnomo} D_w^2}$$

for LWRE crossed roller assembly:

$$k = \frac{2 F_z}{z_{Tnomo} D_w L_{w\ eff}}$$

for needle roller assembly:

$$k = \frac{F_z}{2 z_{Tnomo} D_w L_{w\ eff}}$$

where

- k = specific load per rolling element [N/mm²]
- F_z = single load in z-direction [N]
- z_{Tnomo} = number of rolling elements as control parameter for the nomogram
- D_w = rolling element diameter [mm]
- $L_{w\ eff}$ = contact length of rolling element [mm]

Calculation of resulting deflection:

$$\delta_{res} = f_k \delta$$

where

- δ_{res} = resulting deflection [μ m]
- δ = elastic deformation (determined in nomogram) [μ m]
- f_k = correction factor

Diagram 12

Correction factor f_k for LWRE, LWRM/LWRV and LWM/LWV rail guides

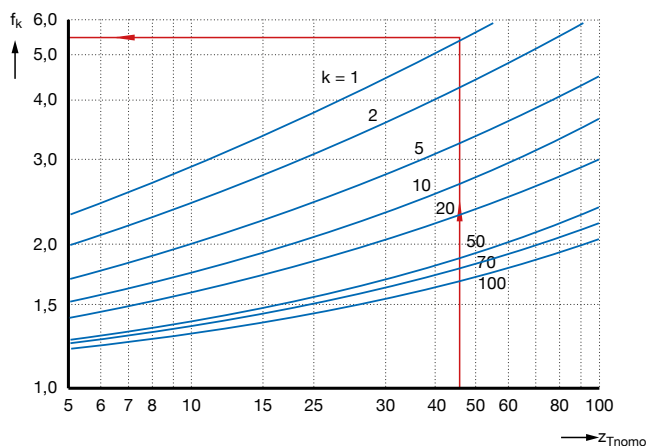
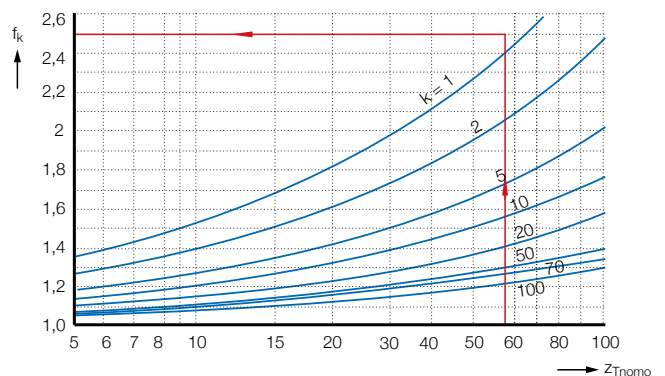

Diagram 13

Correction factor f_k for LWR rail guides



2.6.3 Calculation example for the resulting deflection

The standard Ewellix GCL 6400 slide is loaded in an extended position with a load of 1 000 N as shown in **table 8**. What is the resulting deflection of the LWR6 rail guide at the point where the load is applied in this case? How great would this have been for a LWRE6 rail guide?

The following values have to be determined (↳ **table 8**).

Table 8

Calculation example for the resulting deflection

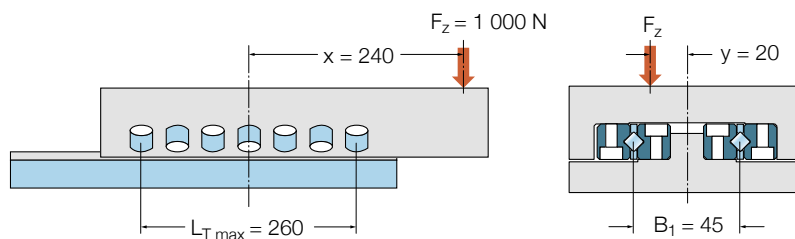

Parameter	Unit	LWR	LWRE
Load carrying length L_T	mm	252	253
Pitch of rolling element assembly t	mm	9	11
Number of rolling elements as control parameter for the nomogram z_{Inomo}		58	48
Leverage ratio $R_x = x/t$		26,7	21,8
Leverage ratio $R_y = y/B_1$		0,44	0,44
Rolling element diameter D_w	mm	6	8
Contact length of rolling element $L_{w\text{eff}}$	mm	2,4	4,7
Average load per rolling element Q	N	34,5	41,7
Elastic deformation δ (determined in nomogram)	μm	13	3,5
Specific load per rolling element k	N/mm^2	0,96	1,1
Correction factor f_k		2,5	5,4
Resulting deflection δ_{res}	μm	32,5	18,9

2.7 Technical data of precision rail guides with slide coating

2.7.1 Surface pressure

To achieve a reasonable value for the contact deformation, the surface pressure of plain bearings or guides is normally in the region of 0,2 to 1 N/mm². **Diagram 14** shows the surface deformation of Turcite-B rail guides expressed in relation to surface pressure. In case of overload, up to 6 N/mm², the contact deformation rises to 5 µm but recovers to the original dimension when the load is relieved.

2.7.2 Wear

LWRPM / LWRPV rail guides are characterized by their high resistance to wear. The ground surface of the LWRPV guides is matched to suit the Turcite-B so that the degree of wear is kept to a minimum. Even a certain amount of contamination can be tolerated without affecting the sliding qualities since the slide material is capable of allowing small particles to become embedded in the surface.

For optimum performance, however, lubrication of the LWRPM / LWRPV rail guides is recommended. As seen in **diagram 15**, the oil-lubricated guide (curve 1) shows less wear along the length of travel in comparison with the non-lubricated guide (curve 2). The values indicated are for an average surface pressure of 0,4 N/mm².

Diagram 14

Contact deformation in relation to surface pressure

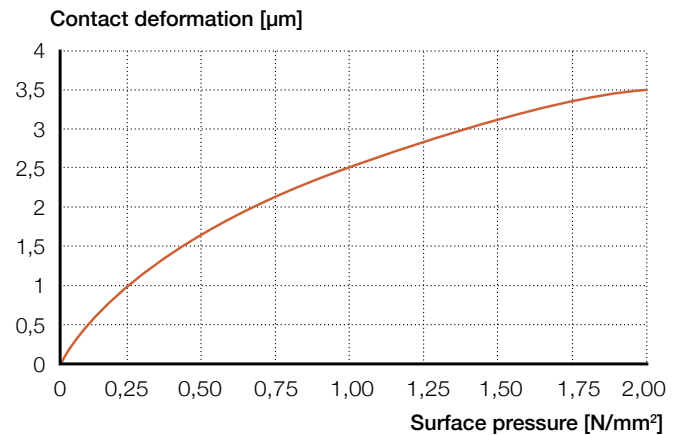
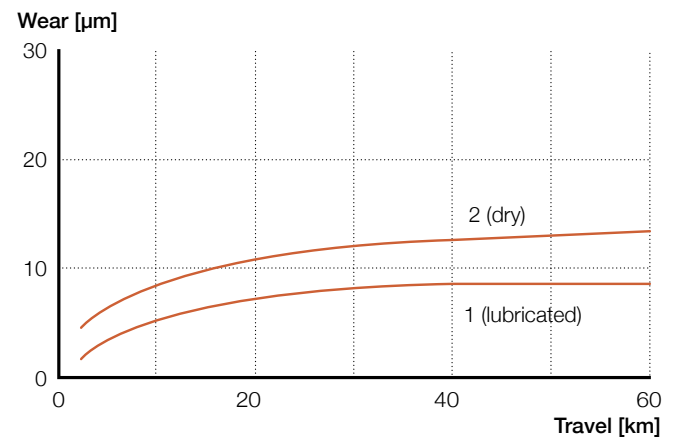

Diagram 15

Wear in relation to length of travel



2.7.3 Frictional properties

Due to the favourable frictional qualities of Turcite-B, the running speed of a dry sliding rail guide has relatively little effect on the coefficient of friction, and 'stick-slip' is virtually eliminated.

Diagram 16 illustrates the relationship between the coefficient of friction for LWRPM / LWRPV rail guides as a function of sliding speed. Curve 1 applies to an oil-lubricated guide, and curve 2 applies to a non-lubricated installation. The degree of friction is seen to fall during a 'smoothing' phase and then remains relatively constant. The values indicated are based on an average surface pressure of 0,2 N/mm².

Diagram 17 shows the coefficient of friction for an oil-lubricated LWRPM / LWRPV rail guide in relation to the surface pressure. Here it will be seen that the coefficient of friction for low load conditions is relatively high, but when the surface pressure reaches 0,2 N/mm², the coefficient falls to a minimum and remains constant.

2.7.4 Temperature range

The operating temperature of a linear plain bearing should lie between the limits of -40 °C and +80 °C. Higher temperatures tend to reduce the pressure resistance. In many cases, the dissipation of heat can be enhanced through the use of lubricating oil.

2.7.5 Chemical and humidity resistance

Turcite-B possesses excellent chemical resistance. Moisture absorbency amounts to a maximum of 0,01 percent and has no significant dimensional effect. Sliding surfaces of Turcite-B are consequently highly resistant to coolants and lubricants.

Diagram 16

Coefficient of friction as a function of sliding speed

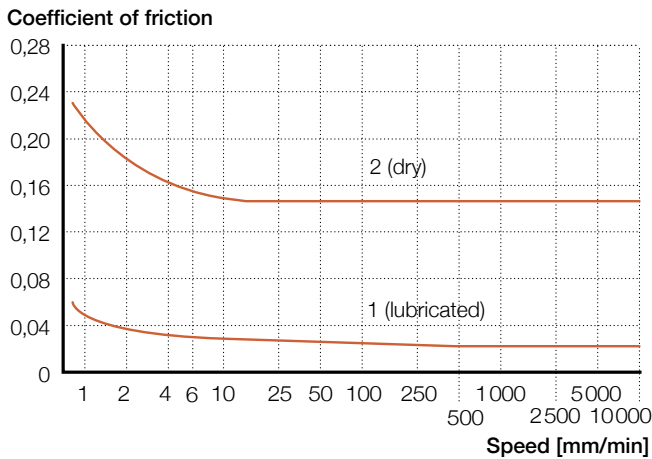
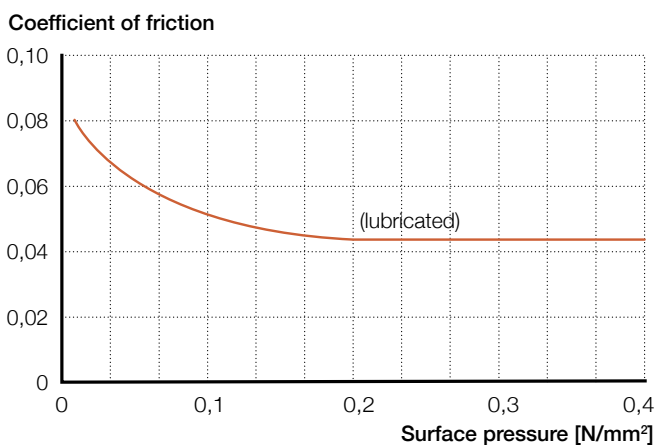

Diagram 17

Coefficient of friction as a function of surface pressure



2.8 Legend

Table 9

Legend		
B_i	mean distance between the rolling element assemblies	[mm]
C	dynamic load rating	[N]
C_0	static load rating	[N]
C_{10}	basic dynamic load rating of a rolling element assembly with 10 rolling elements (balls, rollers) or with 2 rows of 10 needle rollers under load	[N]
$C_{0,10}$	basic static load rating of a rolling element assembly with 10 rolling elements (balls, rollers) or with 2 rows of 10 needle rollers under load	[N]
C_{eff}	effective dynamic load rating for one rolling element assembly	[N]
$C_{eff\ slide}$	effective dynamic load rating of a slide	[N]
$C_{0, eff\ slide}$	effective static load rating of a slide	[N]
c_1	factor for reliability	
δ	elastic deformation (determined in nomogram)	[μ m]
δ_{res}	resulting deflection	[μ m]
E_G	length of lead in radius on each side	[mm]
f_1	factor for load direction	
f_h	factor for hardness, dynamic	
f_{h0}	factor for hardness, static	
f_k	correction factor	
f_{Pr}	factor for preload	[%]
f_{s, s_j}	factor for stroke length	
f_t	factor for operating temperature	
F_{Pr}	preload force	[N]
F_{res}	resulting load	[N]
$F_{res, max}$	maximum resulting load	[N]
$F_{x,i}, F_{y,i}, F_{z,i}$	single loads in x-, y- or z-direction that act simultaneously on the rail guide system	[N]
F_y, F_z	summarized force (load) in y- or z-direction	[N]
k	specific load per rolling element	[N/mm ²]
L_{10h}	basic rating life	[h]
L_{10s}	basic rating life	[km]
L_{ns}	modified basic rating life	[km]
L_{cage}	length of rolling element assembly	[mm]
$L_{cage, max}$	maximum length of rolling element assembly, if length of rail and stroke are predefined	[mm]
$L_{install}$	length of the complete installation	[mm]
L_{rail}	length of the rail	[mm]
$L_{rail, min}$	minimum length of the rail, if length of rolling element assembly and stroke are predefined	[mm]
$L_{rail, long}$	length of the long rail	[mm]
$L_{rail, long, min}$	minimum length of the long rail, if length of rolling element assembly and stroke are predefined	[mm]
$L_{rail, short}$	length of the short rail in an overrunning system	[mm]
L_T	load carrying length	[mm]
$L_{w, eff}$	contact length of rolling element	[mm]
M_x, M_y, M_z	summarized torque loads in x-, y- or z-direction	[Nm]
n	stroke frequency	[double strokes/min]
p	life exponent; $p = 3$ for balls, $p = 10/3$ for rollers	
P	equivalent dynamic load	[N]
P_m	equivalent dynamic mean load	[N]
P_0	maximum static load	[N]
Q	average load per rolling element	[N]
R_x	leverage ratio in x-direction	
R_y	leverage ratio in y-direction	
s_0	static safety factor	
S	intended stroke length	[mm]
S_i	individual stroke length	[mm]
S_{sin}	single stroke length	[mm]
S_{tot}	total stroke length	[mm]
x_i, y_i, z_i	lever arms that are related to the single loads	[m]
w	rolling element exponent; $w = 0,7$ for balls, $w = 7/9$ for rollers	
z	number of rolling elements (per cage or per row for needle rollers)	
z_T	number of load carrying rolling elements (per cage or per row for needle rollers)	
z_{Inomo}	number of rolling elements as control parameter for the nomogram	

Dimensions from product data:

A	width of precision rail guide	[mm]
L	thickness of end piece	[mm]
L_1	thickness of end piece with wiper	[mm]
t	pitch of rolling elements in cage	[mm]
t_1, t_2	distance of outer rolling element to the end of the cage	[mm]
t_3	length of anti-creeping system	[mm]
t_4	elongation of space for cage by eccentricity of the anti-creeping pinion	[mm]
J_1	length between end of rail and first mounting hole	[mm]

Indices

i	counter for single loads in x-, y- or z-direction that act simultaneously
U	number of loads that act simultaneously
j	counter for load phases
V	number of load phases

3

Product Range

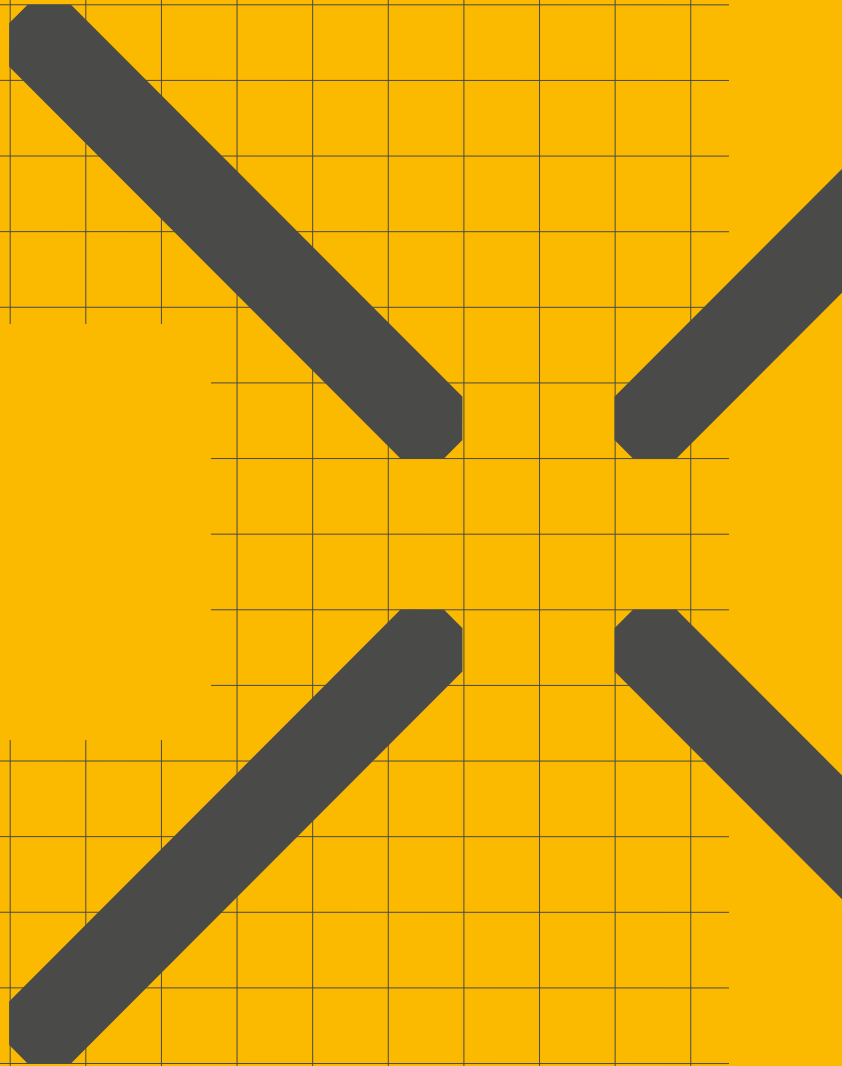

3.1 LWR / LWRB

Rail guides

LWR and LWRB rail guides are well-proven, limited-travel linear guides used in numerous applications. They can be used with crossed roller assemblies or ball assemblies, depending on the respective application. LWR rail guides with crossed roller assemblies are preferred for high load carrying capacity and good rigidity behaviour. LWRB rail guides with ball assembly can be used where loads are light and/or easy running is required. The small cross-section of LWRB is ideal for applications with limited space.

Rolling element assemblies

LWJK ball assemblies, which are used together with LWRB rails, are provided with a ball-retaining plastic cage. They are available for sizes 1 and 2.

LWAK crossed roller assemblies comprise a plastic cage with retained cylindrical rollers, available as standard for size 3.

LWAL crossed roller assemblies, consisting of an aluminium cage with retained rollers, are available in sizes 6 to 12.

End pieces

End pieces prevent drift of the rolling element assemblies away from the loaded zone. Available types are LWERA and LWERB as standard end pieces, as well as LWERC as end pieces with wipers. All end pieces are supplied with appropriate mounting screws.

Ordering example:

4x LWR 9600
2x LWAL 9x25
8x LWERA 9



LWR precision rail guides

Dimensional drawing

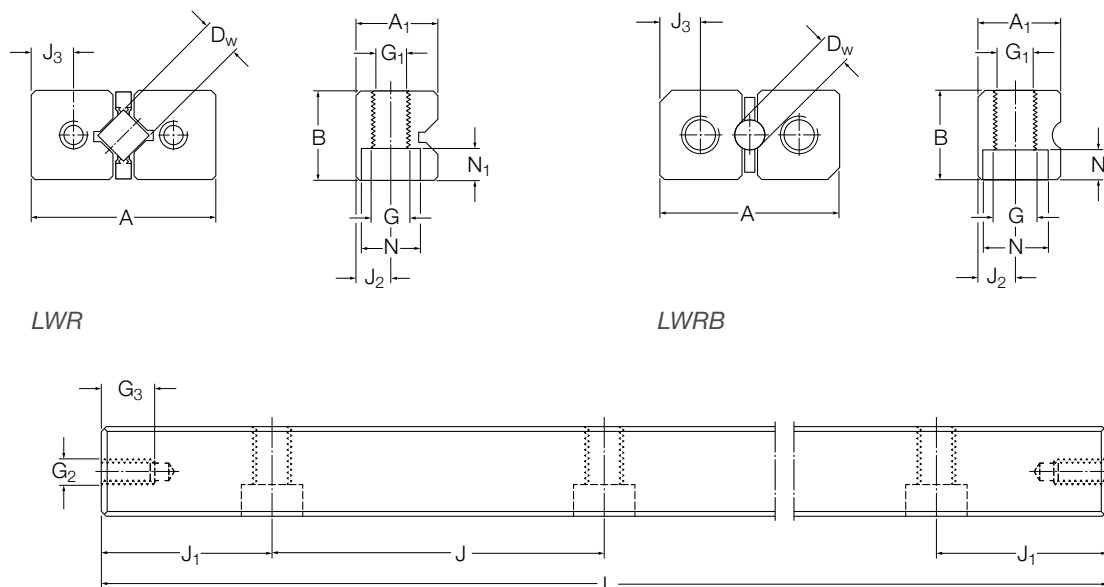

Technical data

Designation ¹⁾	Dimensions				Weight kg/m	Mounting holes								End face holes		
	A mm	B mm	A_1	D_w		J mm	J_1	$J_{1\min}$	J_2	G mm	G_1 mm	N mm	N_1	J_3 mm	G_2 mm	G_3 mm
LWRB 1	8,5	4	3,9	1,588	0,11	10	5	5	1,8	M2	1,65	3	1,4	1,9	M1,6	2
LWRB 2	12	6	5,5	2	0,23	15	7,5	7,5	2,5	M3	2,55	4,4	2	2,7	M2,5	3

Designation ¹⁾	Dimensions				Weight kg/m	Mounting holes								End face holes		
	A mm	B mm	A_1	D_w		J mm	J_1	$J_{1\min}$	J_2	G mm	G_1 mm	N mm	N_1	J_3 mm	G_2 mm	G_3 mm
LWR 3	18	8	8,2	3	0,45	25	12,5	12,5	3,5	M4	3,3	6	3,1	4	M3	6
LWR 6	31	15	13,9	6	1,46	50	25	20	6	M6	5,2	9,5	5,2	7	M5	9
LWR 9	44	22	19,7	9	3,14	100	50	20	9	M8	6,8	10,5	6,2	10	M6	9
LWR 12	58	28	25,9	12	5,23	100	50	25	12	M10	8,5	13,5	8,2	13	M8	12

¹⁾ Sizes LWR 15, 18 and 24 are available with delivery time on request.

LWR rail guides in kit packaging

Designation	Load ratings ¹⁾		Stroke ²⁾ mm	Type of rail 4 pieces	Type of rolling element assembly 2 pieces	Type of end piece 8 pieces
	dyn. C N	stat. C ₀				
–	–	–	–	–	–	–
LWR 3050 – Kit	999	1 120	26	LWR 3050	LWAK 3×7	LWERA 3
LWR 3075 – Kit	1 422	1 760	36	LWR 3075	LWAK 3×11	LWERA 3
LWR 3100 – Kit	1 811	2 400	46	LWR 3100	LWAK 3×15	LWERA 3
LWR 3125 – Kit	2 088	2 880	66	LWR 3125	LWAK 3×18	LWERA 3
LWR 3150 – Kit	2 442	3 520	76	LWR 3150	LWAK 3×22	LWERA 3
LWR 3175 – Kit	2 781	4 160	86	LWR 3175	LWAK 3×26	LWERA 3
LWR 3200 – Kit	3 110	4 800	96	LWR 3200	LWAK 3×30	LWERA 3
LWR 6100 - Kit	4 915	5 440	50	LWR 6100	LWAL 6×8	LWERA 6
LWR 6150 - Kit	6 744	8 160	78	LWR 6150	LWAL 6×12	LWERA 6
LWR 6200 - Kit	8 441	10 880	106	LWR 6200	LWAL 6×16	LWERA 6
LWR 6250 - Kit	10 045	13 600	134	LWR 6250	LWAL 6×20	LWERA 6
LWR 6300 – Kit	11 955	17 000	144	LWR 6300	LWAL 6×25	LWERA 6
LWR 6350 – Kit	13 422	19 720	172	LWR 6350	LWAL 6×29	LWERA 6
LWR 6400 – Kit	14 846	22 440	200	LWR 6400	LWAL 6×33	LWERA 6

¹⁾ Load ratings are given for a kit of 4 rails and 2 rolling element assemblies in clamped arrangement and the standard stroke.

²⁾ The length of the rolling element assembly is adjustable. A shortened cage causes less rolling elements and reduced load ratings (→ chapter 2.4.5). For max. stroke the cage length must not be shorter than 2/3 of the rail length.

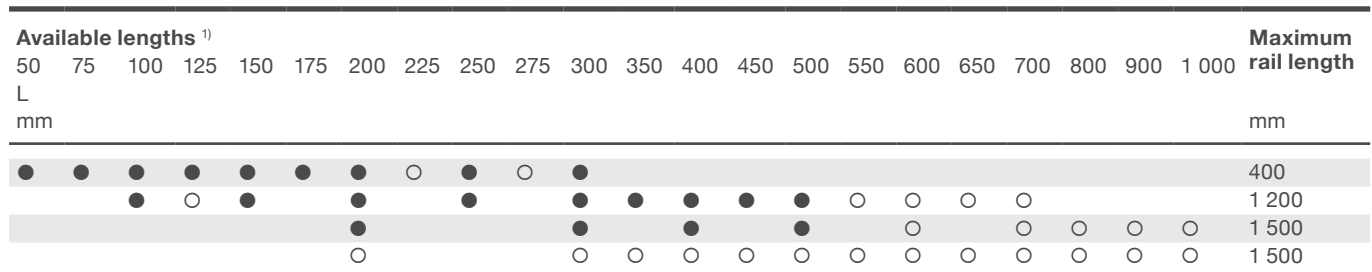
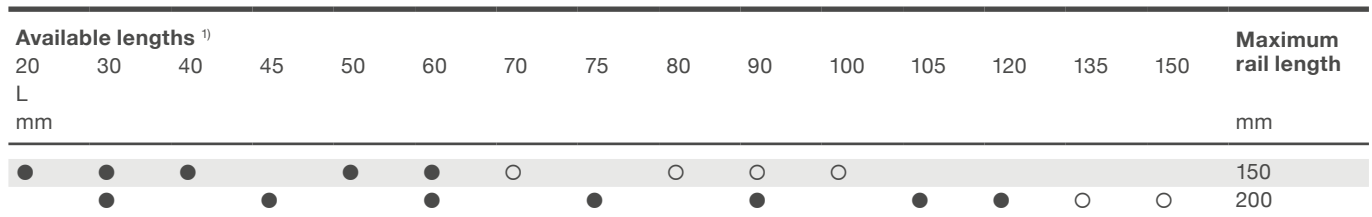

¹⁾ Other rail lengths are available on request but new J_d dimension has to be calculated as described in chapter 4.1.7.

● Prompt delivery

○ Delivery time on request

Ball and crossed roller assemblies

Dimensional drawing

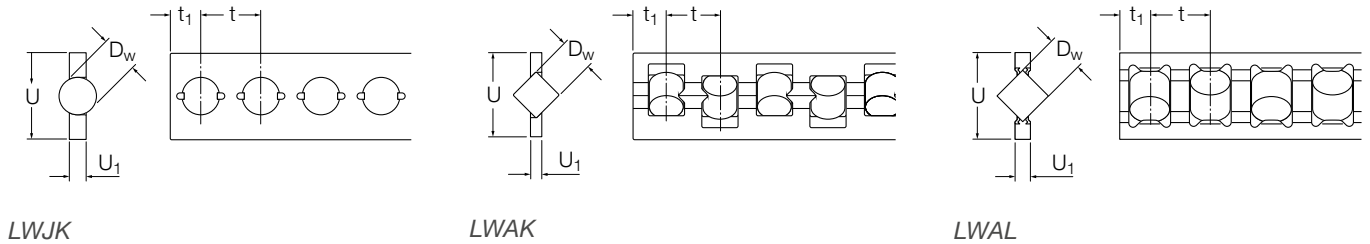

Technical data

Designation	Dimensions					Load ratings for 10 rolling elements		Maximum cage length Balls/Rollers	Weight g/Roller	Appropriate rail guide
	D_w mm	U	U_1	t	t_1	dynamic C_{10} N	static $C_{0.10}$			
LWJK 1,588	1,588	3,5	0,5	2,2	1,4	410	580	38	0,02	LWRB 1
LWJK 2	2	5	0,75	3,9	2,9	640	720	25	0,05	LWRB 2
LWAK 3	3	7,5	1	5	3,5	1 320	1 600	200	0,17	LWR 3
LWAL 6	6	14,8	2,7	9	6	5 850	6 800	166	2	LWR 6
LWAL 9	9	20	4	14	9,4	17 000	18 300	106	6	LWR 9
LWAL 12	12	25	5	18	12	30 000	30 500	83	14	LWR 12

LWR end pieces

Dimensional drawing

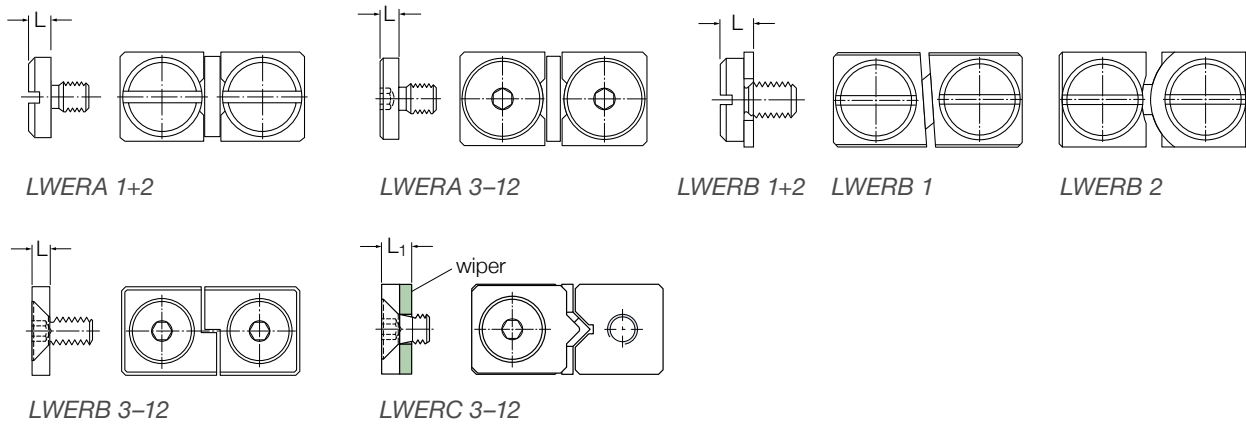

Technical data

Designation		Dimensions		Attachment screw		Appropriate rail guide	Material of wiper
End pieces	End pieces with wiper	L mm	L ₁	ISO 1580	ISO 10642		
-	-	-	-	-	-	-	-
LWERA 1		1				LWRB 1	
LWERB 1		1,8		M 1,6			
LWERA 2		1,5				LWRB 2	
LWERB 2		2		M 2,5			
LWERA 3		2,5				LWR 3	
LWERB 3		2			M 3		
	LWERC 3		5		M 3		Felt
LWERA 6		3				LWR 6	
LWERB 6		3			M 5		
	LWERC 6		6		M 5		Felt
LWERA 9		4				LWR 9	
LWERB 9		4			M 6		
	LWERC 9		7		M 6		Felt
LWERA 12		5				LWR 12	
LWERB 12		5			M 8		
	LWERC 12		8		M 8		Felt

3.2 LWRE

Rail guides

LWRE rail guides are a logical development of the proven LWR rail guides. In addition to the familiar characteristics of the LWR series, LWRE rail guides offer the advantages of fivefold load ratings and a doubling of the rigidity. This means that for the same load capacity, a 50% reduction in bearing size compared with the standard LWR rail guide is possible (↳ **fig. 1**). Alternatively, with the same outer dimensions, greatly increased static safety and lifetime result.

The improvements are achieved through optimized internal geometry in conjunction with larger roller diameters. Furthermore, LWRE rail guides utilize the whole roller length so that no tilting moment or edge stresses can occur (↳ **fig. 2**). The mounting and attachment dimensions of the LWRE rail guides conform to those of all the Ewellix Modular Range rail guides included in this catalogue.

Rolling element assemblies

LWAKE crossed roller assemblies consist of individual plastic elements. In LWAKE 3, 6 and 9 cages, these elements are assembled using a 'snap in' technique, whereby each element can be rotated manually through an angle of 90° (↳ **fig. 3**). The load rating and rigidity can be increased by turning the rollers in the direction of the main load. As standard, the orientation of the rollers relative to each other varies (↳ **fig. 3**, upper illustration). The cage retains the rollers and at the same time almost fills the free space between the rails, thus providing good protection against ingress of dirt. LWAKE 4 cages consist of roller segments fitted together to the customer's specific length requirements. Individual rotating is not possible for size 4.

End pieces

End pieces prevent drift of the rolling element assemblies away from the loaded zone. LWRE end pieces are generally used for horizontal and vertical applications. An end piece with wiper, LWEREC, is available. All end pieces are supplied with appropriate mounting screws.

Ordering example:

4x LWRE 6200
2x LWAKE 6x13
8x LWERE 6



Fig. 1

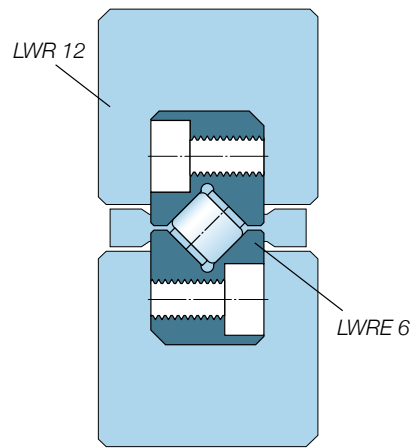

Fig. 2

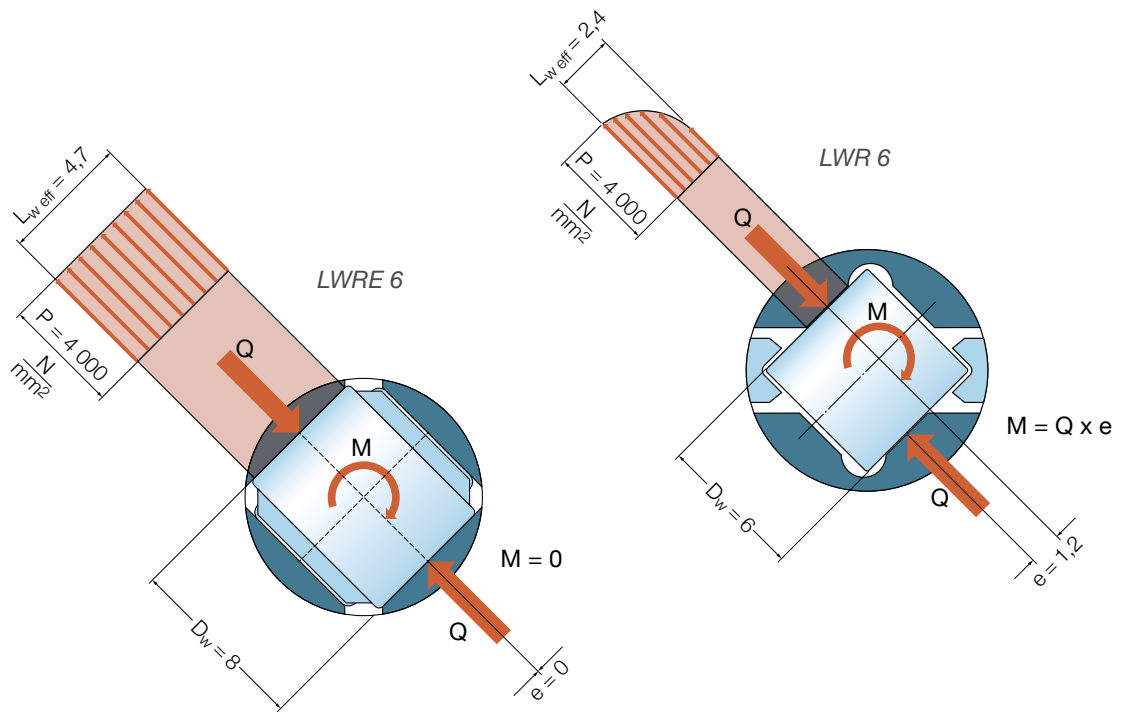
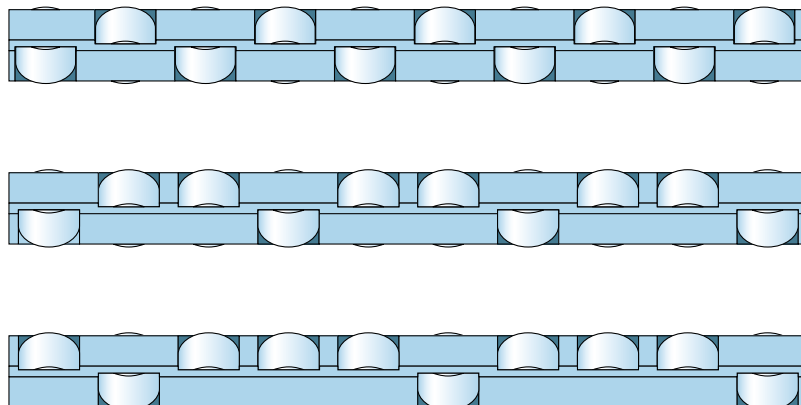
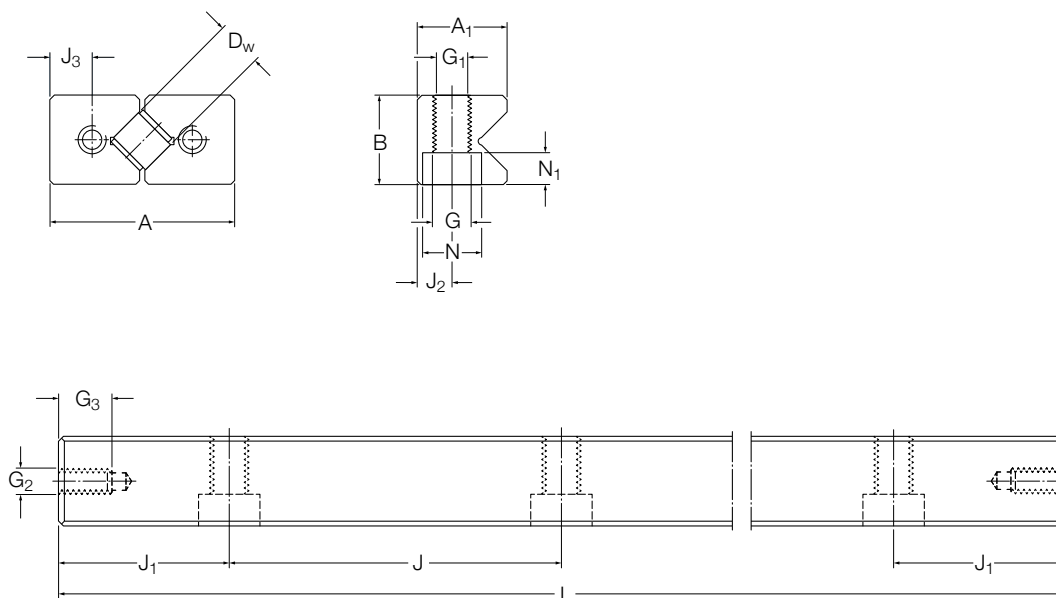

Fig. 3



LWRE precision rail guides

Dimensional drawing



Technical data

Designation	Dimensions				Weight kg/m	Mounting holes								End face holes		
	A mm	B mm	A ₁ mm	D _w mm		J mm	J ₁ mm	J _{1min} mm	J ₂ mm	G mm	G ₁ mm	N mm	N ₁ mm	J ₃ mm	G ₂ mm	G ₃ mm
LWRE 3	18	8	8,7	4	0,44	25	12,5	12,5	3,5	M 4	3,3	6	3	4	M 3	6
LWRE 4	25	12	12	6,5	0,93	25	12,5	12,5	5	M 4	3,3	6	3,2	5	M 3	6
LWRE 6	31	15	15,2	8	1,44	50	25	20	6	M 6	5,2	9,5	5,2	6,75	M 5	9
LWRE 9	44	22	21,7	12	3,09	100	50	20	9	M 8	6,8	10,5	6,2	9,75	M 6	9

Designation	Dimensions				Weight kg/m	Mounting holes								End face holes		
	A mm	B mm	A ₁ mm	D _w mm		J mm	J ₁ mm	J _{1min} mm	J ₂ mm	G mm	G ₁ mm	N mm	N ₁ mm	J ₃ mm	G ₂ mm	G ₃ mm
LWRE 2211	22	11	10,7	4	0,8	40	20	15	4,5	M 5	4,3	7,5	4,1	6	M 3	6

LWRE rail guides in kit packaging

Designation	Load ratings ¹⁾		Stroke ²⁾ mm	Type of rail 4 pieces	Type of rolling element assembly 2 pieces	Type of end piece 8 pieces
	dyn. C N	stat. C ₀				
LWRE 3050 – Kit	4 230	5 100	25	LWRE 3050	LWAKE 3×6	LWERE 3
LWRE 3075 – Kit	5 803	7 650	37,5	LWRE 3075	LWAKE 3×9	LWERE 3
LWRE 3100 – Kit	7 263	10 200	50	LWRE 3100	LWAKE 3×12	LWERE 3
LWRE 3125 – Kit	8 644	12 750	62,5	LWRE 3125	LWAKE 3×15	LWERE 3
LWRE 3150 – Kit	9 964	15 300	75	LWRE 3150	LWAKE 3×18	LWERE 3
LWRE 3175 – Kit	11 238	17 850	87,5	LWRE 3175	LWAKE 3×21	LWERE 3
LWRE 3200 – Kit	12 471	20 400	100	LWRE 3200	LWAKE 3×24	LWERE 3
LWRE 4100 – Kit	17 300	20 800	38,8	LWRE 4100	LWAKE 4×10	LWERE 4
LWRE 4150 – Kit	23 735	31 200	58,8	LWRE 4150	LWAKE 4×15	LWERE 4
LWRE 4200 – Kit	28 541	39 520	94,8	LWRE 4200	LWAKE 4×19	LWERE 4
LWRE 4250 – Kit	34 246	49 920	114,8	LWRE 4250	LWAKE 4×24	LWERE 4
LWRE 4300 – Kit	38 622	58 240	150,8	LWRE 4300	LWAKE 4×28	LWERE 4
LWRE 4350 – Kit	43 902	68 640	170,8	LWRE 4350	LWAKE 4×33	LWERE 4
LWRE 4400 – Kit	49 009	79 040	190,8	LWRE 4400	LWAKE 4×38	LWERE 4
LWRE 6100 – Kit	25 743	27 300	46	LWRE 6100	LWAKE 6×7	LWERE 6
LWRE 6150 – Kit	34 000	39 000	80	LWRE 6150	LWAKE 6×10	LWERE 6
LWRE 6200 – Kit	44 204	54 600	92	LWRE 6200	LWAKE 6×14	LWERE 6
LWRE 6250 – Kit	51 431	66 300	126	LWRE 6250	LWAKE 6×17	LWERE 6
LWRE 6300 – Kit	58 382	78 000	160	LWRE 6300	LWAKE 6×20	LWERE 6
LWRE 6350 – Kit	67 304	93 600	172	LWRE 6350	LWAKE 6×24	LWERE 6
LWRE 6400 – Kit	73 781	105 300	206	LWRE 6400	LWAKE 6×27	LWERE 6

¹⁾ Load ratings are given for a kit of 4 rails and 2 rolling element assemblies in clamped arrangement and the standard stroke.

²⁾ The length of the rolling element assembly is adjustable. A shortened cage causes less rolling elements and reduced load ratings (→ chapter 2.4.5). For max. stroke the cage length must not be shorter than 2/3 of the rail length.

Available lengths ¹⁾																			Maximum rail length			
50	75	100	125	150	175	200	225	250	275	300	350	400	450	500	550	600	650	700		800	900	1 000
L																						mm
●	●	●	●	●	●	●	○	○	○	○												400
		●		●		●		●		●		●	○	○	○	○			○			700
		●		●		●		●		●	○	●	○	○	○	○	○	○				1 200
						●				●		●		●		○	○	○	○	○	○	1 500

Available lengths ¹⁾										Maximum rail length
80	120	160	200	240	280	320	360	400		
L										mm
○	○	○	○	○	○	○	○	○	○	500

¹⁾ Other rail lengths are available on request but new J₁ dimension has to be calculated as described in chapter 4.1.7.

- Prompt delivery
- Delivery time on request



Crossed roller assemblies

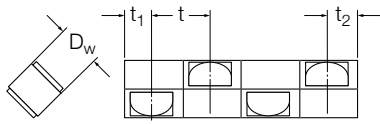

LWAKE 3, 6, 9

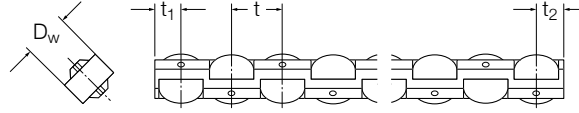

LWAKE 4

Designation	Dimensions				Load ratings for 10 rolling elements		Maximum cage length ¹⁾ mm	Weight g/Roller	Appropriate rail guide
	D _w mm	t	t ₁	t ₂	dynamic C ₁₀ N	static C _{0,10}			
–									–
LWAKE 3	4	6,25	2,65	3,6	6 300	8 500	400	0,4	LWRE 3, LWRE 2211
LWAKE 4	6,5	8	4,3	4,3	17 300	20 800	700	1,2	LWRE 4
LWAKE 6	8	11	5	6	34 000	39 000	1 000	2,6	LWRE 6
LWAKE 9	12	16	7,35	8,65	78 000	78 000	1 000	9,2	LWRE 9

¹⁾ Longer cages are available on request.

LWRE end pieces

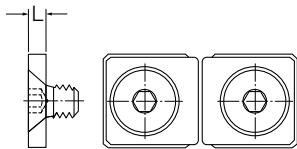

LWERE 3, 6, 9

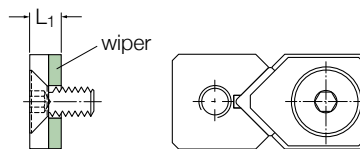

LWEREC 3, 6, 9

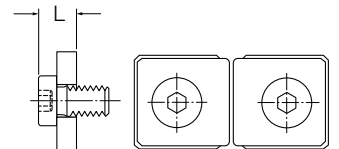

LWERE 4

Designation	Dimensions	Attachment screw	Appropriate rail guide	Material of wiper
End pieces	End pieces with wiper	ISO 10642		
–	L mm	L ₁	–	–
LWERE 3	2	M 3	LWRE 3, LWRE 2211	
LWEREC 3	4	M 3	LWRE 3, LWRE 2212	TPUR
LWERE 4	4	M 3 (DIN 7984)	LWRE 4	
LWERE 6	3	M 5	LWRE 6	
LWEREC 6	5	M 5	LWRE 6	TPUR
LWERE 9	3	M 6	LWRE 9	
LWEREC 9	6	M 6	LWRE 9	TPUR

3.3 LWRE ACS

Rail guides

LWRE ACS rail guides are identical to LWRE rail guides, but designed for use with anti-creeping LWAKE ACS cages. The non-slip effect is achieved through a patented control gear attached to the cage, which is in mesh between the LWRE ACS rails during operation, thus retaining the rolling element assembly in its defined position. As standard, the rails are teathed over their entire length (↳ **chapter 1.3**).

Rolling element assemblies

In principle, LWAKE ACS cages are the same as LWAKE cages, but LWAKE ACS crossed roller assemblies incorporate an additional control gear located at the centre of the cage. The load carrying capacity of LWAKE ACS crossed roller assemblies is also identical with that of LWAKE standard crossed roller assemblies, assuming that they comprise an identical number of rollers. However, consider that due to their additional control gear, LWAKE ACS cages are longer than the corresponding LWAKE cages, even if the number of rollers is identical. Overrunning rolling element assemblies should only be used after consulting Ewellix.

End pieces

End pieces are generally not needed, but for production reasons, the tapped holes on the rail's end face are standard and end pieces can be mounted. LWERE end pieces are generally used for horizontal and vertical applications. An end piece with wiper, LWEREC, is available. All end pieces are supplied with appropriate mounting screws.

The end pieces for LWRE rail guides are also suitable for LWRE ACS rail guides.

Ordering example:

4x LWRE 6200 ACS
2x LWAKE 6x12 ACS
8x LWERE 6



LWRE ACS precision rail guides

Dimensional drawing

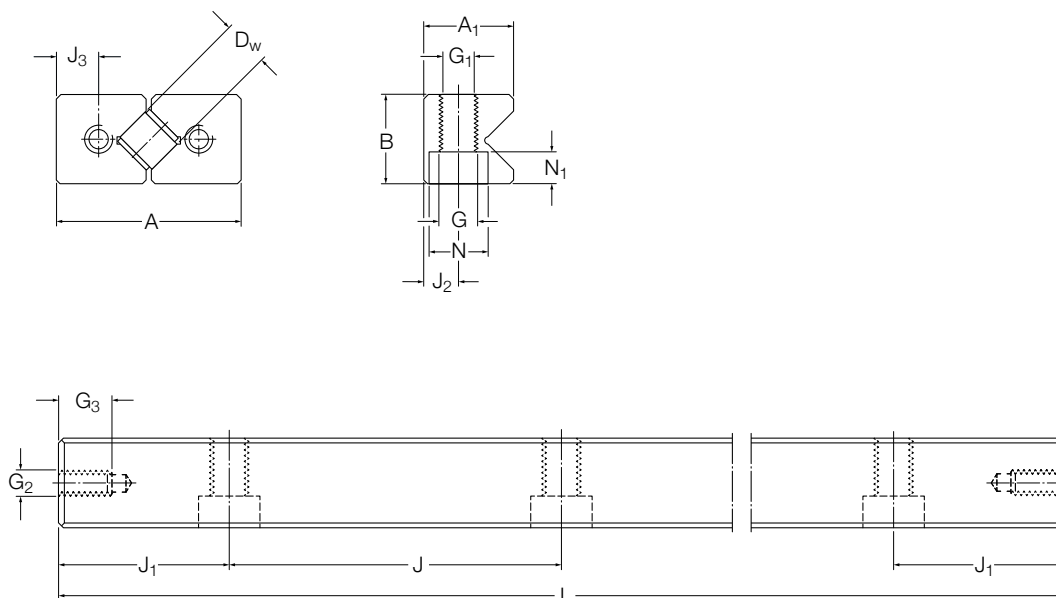

Technical data

Designation	Dimensions				Weight kg/m	Mounting holes								End face holes		
	A mm	B mm	A ₁ mm	D _w mm		J mm	J ₁ mm	J _{1min} mm	J ₂ mm	G mm	G ₁ mm	N mm	N ₁ mm	J ₃ mm	G ₂ mm	G ₃ mm
LWRE 3 ACS	18	8	8,7	4	0,44	25	12,5	12,5	3,5	M 4	3,3	6	3	4	M 3	6
LWRE 4 ACS	25	12	12	6,5	0,92	25	12,5	12,5	5	M 4	3,3	6	3,2	5	M 3	6
LWRE 6 ACS	31	15	15,2	8	1,44	50	25	20	6	M 6	5,2	9,5	5,2	6,75	M 5	9
LWRE 9 ACS	44	22	21,7	12	3,08	100	50	20	9	M 8	6,8	10,5	6,2	9,75	M 6	9

Designation	Dimensions				Weight kg/m	Mounting holes								End face holes		
	A mm	B mm	A ₁ mm	D _w mm		J mm	J ₁ mm	J _{1min} mm	J ₂ mm	G mm	G ₁ mm	N mm	N ₁ mm	J ₃ mm	G ₂ mm	G ₃ mm
LWRE 2211 ACS	22	11	10,7	4	0,8	40	20	15	4,5	M 5	4,3	7,5	4,1	6	M 3	6

LWRE ACS rail guides in kit packaging

Designation	Load ratings ¹⁾		Stroke ²⁾ mm	Type of rail 4 pieces	Type of rolling element assembly 2 pieces	Type of end piece 8 pieces
	dyn. C N	stat. C ₀				
LWRE 3050 ACS – Kit	3 465	4 250	17,7	LWRE 3050 ACS	LWAKE 3×5 ACS	LWERE 3
LWRE 3075 ACS – Kit	4 230	5 100	55,2	LWRE 3075 ACS	LWAKE 3×6 ACS	LWERE 3
LWRE 3100 ACS – Kit	6 300	8 500	55,2	LWRE 3100 ACS	LWAKE 3×10 ACS	LWERE 3
LWRE 3125 ACS – Kit	7 731	11 050	67,7	LWRE 3125 ACS	LWAKE 3×13 ACS	LWERE 3
LWRE 3150 ACS – Kit	9 090	13 600	80,2	LWRE 3150 ACS	LWAKE 3×16 ACS	LWERE 3
LWRE 3175 ACS – Kit	9 964	15 300	105,2	LWRE 3175 ACS	LWAKE 3×18 ACS	LWERE 3
LWRE 3200 ACS – Kit	11 653	18 700	105,2	LWRE 3200 ACS	LWAKE 3×22 ACS	LWERE 3
LWRE 4100 ACS – Kit	14 536	16 640	34	LWRE 4100 ACS	LWAKE 4×8 ACS	LWERE 4
LWRE 4150 ACS – Kit	19 944	24 960	70	LWRE 4150 ACS	LWAKE 4×12 ACS	LWERE 4
LWRE 4200 ACS – Kit	26 170	35 360	90	LWRE 4200 ACS	LWAKE 4×17 ACS	LWERE 4
LWRE 4250 ACS – Kit	30 859	43 680	126	LWRE 4250 ACS	LWAKE 4×21 ACS	LWERE 4
LWRE 4300 ACS – Kit	36 452	54 080	146	LWRE 4300 ACS	LWAKE 4×26 ACS	LWERE 4
LWRE 4350 ACS – Kit	41 813	64 480	166	LWRE 4350 ACS	LWAKE 4×31 ACS	LWERE 4
LWRE 4400 ACS – Kit	45 964	72 800	202	LWRE 4400 ACS	LWAKE 4×35 ACS	LWERE 4
LWRE 6100 ACS – Kit	22 826	23 400	34,4	LWRE 6100 ACS	LWAKE 6×6 ACS	LWERE 6
LWRE 6150 ACS – Kit	31 318	35 100	68,4	LWRE 6150 ACS	LWAKE 6×9 ACS	LWERE 6
LWRE 6200 ACS – Kit	39 196	46 800	102,4	LWRE 6200 ACS	LWAKE 6×12 ACS	LWERE 6
LWRE 6250 ACS – Kit	49 056	62 400	114,4	LWRE 6250 ACS	LWAKE 6×16 ACS	LWERE 6
LWRE 6300 ACS – Kit	56 093	74 100	148,4	LWRE 6300 ACS	LWAKE 6×19 ACS	LWERE 6
LWRE 6350 ACS – Kit	65 107	89 700	160,4	LWRE 6350 ACS	LWAKE 6×23 ACS	LWERE 6
LWRE 6400 ACS – Kit	71 640	101 400	194,4	LWRE 6400 ACS	LWAKE 6×26 ACS	LWERE 6

¹⁾ Load ratings are given for a kit of 4 rails and 2 rolling element assemblies in clamped arrangement and the standard stroke.

²⁾ The length of the rolling element assembly is adjustable. A shortened cage causes less rolling elements and reduced load ratings (→ chapter 2.4.5). For max. stroke the cage length must not be shorter than 2/3 of the rail length..

Available lengths ¹⁾																			Maximum rail length			
50	75	100	125	150	175	200	225	250	275	300	350	400	450	500	550	600	650	700		800	900	1 000
L																						
mm																						
	●	●	●	●	●	●	○	○	○	○												400
			○	○	○	○	○	○	○	○	○	○	○	○	○	○	○	○	○	○	○	700
		●	●	●	○	○	○	○	○	○	○	○	○	○	○	○	○	○	○	○	○	1 200
						○				○	○	○	○	○	○	○	○	○	○	○	○	1 500

Available lengths ¹⁾										Maximum rail length
80	120	160	200	240	280	320	360	400		
L										
mm										
	○	○	○	○	○	○	○	○	○	500

¹⁾ Other rail lengths are available on request but new J_d dimension has to be calculated as described in chapter 4.1.7.

- Prompt delivery
- Delivery time on request



Crossed roller assemblies

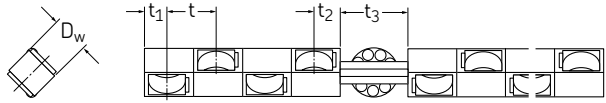

LWAKE 3, 6, 9 ACS

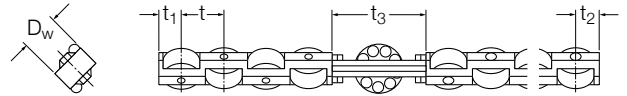

LWAKE 4 ACS

Designation	Dimensions						Load ratings for 10 rolling elements		Maximum cage length ¹⁾	Weight	Weight ACS unit	Appropriate rail guide
	D _w mm	t	t ₁	t ₂	t ₃	t ₄	dynamic C ₁₀ N	static C _{0.10}				
–									mm	g/Roller g	–	
LWAKE 3 ACS	4	6,25	2,65	3,6	9	0,9	6 300	8 500	400	0,4	<1	LWRE 3 ACS, LWRE 2211 ACS
LWAKE 4 ACS	6,5	8	4,3	4,3	17	1,4	17 300	20 800	700	1,2	<1	LWRE 4 ACS
LWAKE 6 ACS	8	11	5	6	15	1,8	34 000	39 000	1 000	2,6	1	LWRE 6 ACS
LWAKE 9 ACS	12	16	7,35	8,65	21,5	2,5	78 000	78 000	1 000	9,2	3	LWRE 9 ACS

¹⁾ Longer cages are available on request.

LWRE ACS end pieces

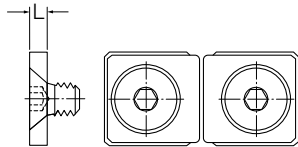

LWERE 3, 6, 9

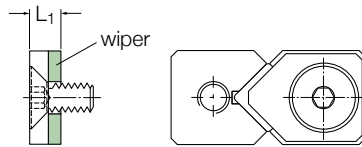

LWEREC 3, 6, 9

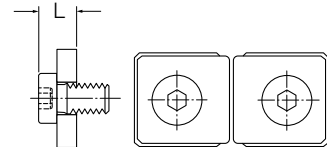

LWERE 4

Designation	Dimensions	Attachment screw	Appropriate rail guide	Material of wiper
End pieces	End pieces with wiper	ISO 10642		
–	L mm L ₁	–	–	–
LWERE 3	2	M 3	LWRE 3, LWRE 2211	
LWEREC 3	4	M 3	LWRE 3, LWRE 2212	TPUR
LWERE 4	4	M 3 (DIN 7984)	LWRE 4	
LWERE 6	3	M 5	LWRE 6	
LWEREC 6	5	M 5	LWRE 6	TPUR
LWERE 9	3	M 6	LWRE 9	
LWEREC 9	6	M 6	LWRE 9	TPUR

3.4 LWRE / LWRB ACSM

Rail guides

The refinement of our own ACS solution became the LWRE and LWRB ACSM rail guide version. LWRE and LWRB ACSM rail guides have the same outer dimensions as those without ACSM, but are designed for use with anti-creeping LWAKE ACSM cages. This cage, with an involute-toothed control gear made of brass and a rack directly machined into the rail, prevent cage-creeping very effectively and are especially suited for applications with high accelerations (→ [chapter 1.3](#)). These rails are made of stainless steel as standard.

Rolling element assemblies

In principle, LWAKE ACSM cages are the same as LWAKE cages, but LWAKE ACSM crossed roller assemblies incorporate an additional control gear made of brass located at the centre of the cage. When defining the length of the rolling element assembly, the additional length of the control gear should be considered. Overrunning rolling element assemblies should only be used after consulting Ewellix. The given load capacities are already calculated for stainless steel rails, which means factor f_h remains at one for calculation of the lifetime.

End pieces

Generally, the LWRE ACSM rail guides are not designed for use with end pieces. However, if they are required, this must be stated separately in the ordering code of the rail (Option E7). The end pieces for LWRE rail guides are also suitable for LWRE ACSM rail guides.

Ordering example:

4x LWRE 3150 ACSM
2x LWAKE 3x16 ACSM



LWRE ACSM precision rail guides

Dimensional drawing

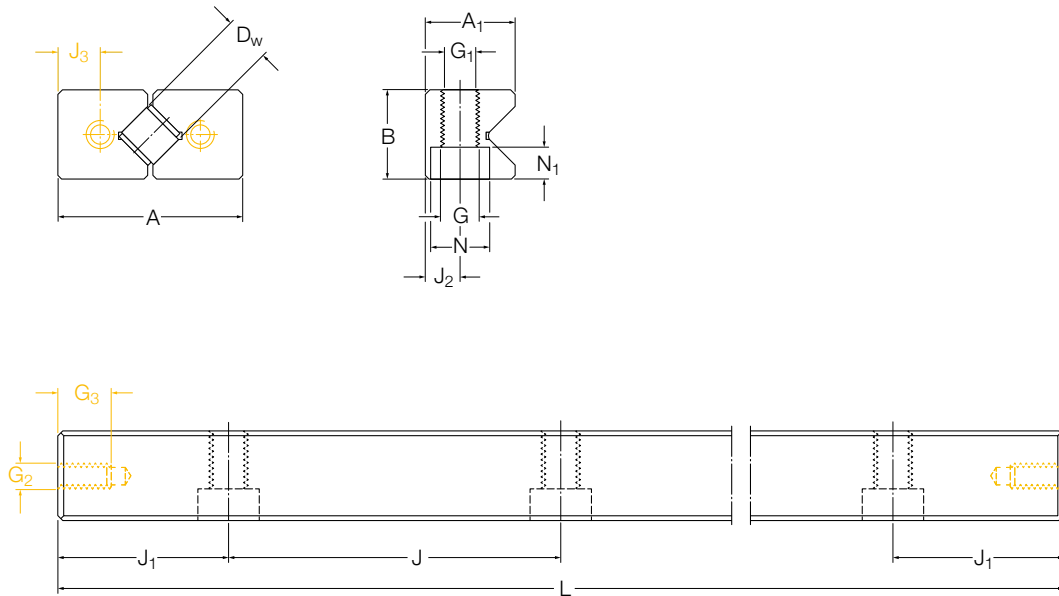

Technical data

Designation	Dimensions				Weight kg/m	Mounting holes								End face holes ¹⁾²⁾		
	A mm	B	A ₁	D _w		J mm	J ₁	J _{1 min}	J ₂	G	G ₁ mm	N	N ₁	J ₃ mm	G ₂ -	G ₃ mm
LWRB 2 ACSM	12	6	5,5	2	0,23	15	7,5	7,5	2,5	M 3	2,55	4,4	2	2,7	M 2,5	3
LWRE 3 ACSM	18	8	8,7	4	0,44	25	12,5	12,5	3,5	M 4	3,3	6	3	4	M 3	6
LWRE 4 ACSM	25	12	12	6,5	0,91	25	12,5	12,5	5	M 4	3,3	6	3,2	5	M 3	6
LWRE 6 ACSM	31	15	15,2	8	1,42	50	25	20	6	M 6	5,2	9,5	5,2	6,75	M 5	9
LWRE 9 ACSM	44	22	21,7	12	3,05	100	50	20	9	M 8	6,8	10,5	6,2	9,75	M 6	9

Designation	Dimensions				Weight kg/m	Mounting holes								End face holes ¹⁾²⁾		
	A mm	B	A ₁	D _w		J mm	J ₁	J _{1 min}	J ₂	G	G ₁ mm	N	N ₁	J ₃ mm	G ₂ -	G ₃ mm
LWRE 2211 ACSM	22	11	10,7	4	0,79	40	20	15	4,5	M 5	4,3	7,5	4,1	6	M 3	6

¹⁾ Standard is without end face holes; Option E7 means with end face holes (yellow lines)

²⁾ Standard is without end face holes, thus these ACSM-rails can be equipped - on customer demand - with 1 additional mounting hole, if a certain condition is fulfilled. Please address your request by specifying length J₁ in the ordering key. If this option is chosen, they aren't compatible with rails designed for end pieces.

LWRE ACSM rail guides in kit packaging

Designation	Load ratings ^{1), 2)}		Stroke ³⁾ mm	Type of rail 4 pieces	Type of rolling element assembly 2 pieces
	dyn. C N	stat. C ₀			
LWRE 3050 ACSM – Kit	2 940	4 080	17,9	LWRE 3050 ACSM	LWAKE 3×5 ACSM
LWRE 3075 ACSM – Kit	3 380	4 900	55,4	LWRE 3075 ACSM	LWAKE 3×6 ACSM
LWRE 3100 ACSM – Kit	5 040	8 160	55,4	LWRE 3100 ACSM	LWAKE 3×10 ACSM
LWRE 3125 ACSM – Kit	6 180	10 610	67,9	LWRE 3125 ACSM	LWAKE 3×13 ACSM
LWRE 3150 ACSM – Kit	7 270	13 060	80,4	LWRE 3150 ACSM	LWAKE 3×16 ACSM
LWRE 3175 ACSM – Kit	7 970	14 690	105,4	LWRE 3175 ACSM	LWAKE 3×18 ACSM
LWRE 3200 ACSM – Kit	9 320	17 950	105,4	LWRE 3200 ACSM	LWAKE 3×22 ACSM
LWRE 6100 ACSM – Kit	18 260	22 460	35,8	LWRE 6100 ACSM	LWAKE 6×6 ACSM
LWRE 6150 ACSM – Kit	25 050	33 700	69,8	LWRE 6150 ACSM	LWAKE 6×9 ACSM
LWRE 6200 ACSM – Kit	31 360	44 930	103,8	LWRE 6200 ACSM	LWAKE 6×12 ACSM
LWRE 6250 ACSM – Kit	39 240	59 900	115,8	LWRE 6250 ACSM	LWAKE 6×16 ACSM
LWRE 6300 ACSM – Kit	44 870	71 140	149,8	LWRE 6300 ACSM	LWAKE 6×19 ACSM
LWRE 6350 ACSM – Kit	52 090	86 110	161,8	LWRE 6350 ACSM	LWAKE 6×23 ACSM
LWRE 6400 ACSM – Kit	57 310	97 340	195,8	LWRE 6400 ACSM	LWAKE 6×26 ACSM

¹⁾ Load ratings are given for a kit of 4 rails and 2 rolling element assemblies in clamped arrangement and the standard stroke.

²⁾ Calculated with HRC 55 due to stainless rails.

³⁾ The length of the rolling element assembly is adjustable. A shortened cage causes less rolling elements and reduced load ratings (→ chapter 2.4.5).
For max. stroke the cage length must not be shorter than 2/3 of the rail length.

Available lengths ¹⁾																			Maximum rail length	
30	45	50	60	75	90	100	105	120	125	135	150	175	200	225	250	275	300	350		400
L																				
mm																				mm
○	○		○	○	○		○	○		○	○		●	●	●	●	●	●	●	200
		●		●		●		●		●	●	●	●	●	●	●	●	●	●	400
						○				○			○		○		○		○	400
						●				●			●		●		●		●	400
													○				○		●	400

Available lengths ¹⁾										Maximum rail length
80	120	160	200	240	280	320	360	400		
L										
mm										mm
○	○	○	○	○	○	○	○	○	○	400

¹⁾ Other rail lengths are available on request but new J₁ dimension has to be calculated as described in chapter 4.1.7.

● Prompt delivery

○ Delivery time on request



Ball and crossed roller assemblies

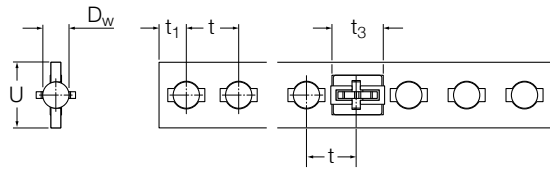

LWJK 2 ACSM

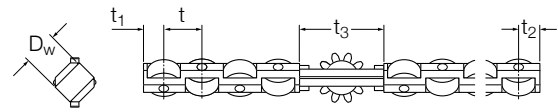

LWAKE 4 ACSM

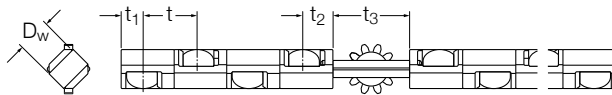

LWAKE 3, 6, 9 ACSM

Designation	Dimensions						Load ratings for 10 rolling elements		Maximum cage length ¹⁾ mm	Weight g/Roller	Weight ACSM unit g	Appropriate rail guide
	D _w mm	t	t ₁	t ₂	t ₃	t ₄	dynamic C ₁₀ N	static C _{0.10}				
LWJK 2 ACSM	2	3,9	2,9	–	3,9	0,5	510	650	24 balls	0,05	<1	LWRB 2 ACSM
LWAKE 3 ACSM	4	6,25	2,65	3,6	9	0,8	5 040	8 160	400	0,4	<1	LWRE 3 ACSM, LWRE 2211 ACSM
LWAKE 4 ACSM	6,5	8	4,3	4,3	17	1,1	13 840	19 968	400	1,2	1	LWRE 4 ACSM
LWAKE 6 ACSM	8	11	5	6	15	1,1	27 200	37 440	400	2,6	3	LWRE 6 ACSM
LWAKE 9 ACSM	12	16	7,35	8,65	21,5	1,1	62 400	74 880	400	9,2	5	LWRE 9 ACSM

¹⁾ Longer cages are available on request.

3.5 LWRM / LWRV

Rail guides

LWRM/LWRV rail guides offer guiding systems with high load carrying capacity and maximum rigidity.

The mounting and interface dimensions of LWRM/LWRV rail guides conform to those of all the Ewellix Modular Range rail guides included in this catalogue.

Rolling element assemblies

LWHW needle roller assemblies have aluminium cages with retained needle rollers. LWHV needle roller assemblies consist of a plastic cage with retained needle rollers.

They are available for size 6 and 9 units. When ordering, the appropriate cage length in mm should be stated after the designation of the rolling element assembly, e.g.: LWHW 10x225.

End pieces

End pieces serve to prevent the drift of the rolling element assemblies away from the loaded zone. Because of the design of LWRM/LWRV rail guides and the respective end pieces, only one rail, the M-shaped or the V-shaped, needs to be equipped with end pieces. LWEARM and LWEARV end pieces feature a plastic wiper with a sealing lip that keeps the raceways virtually free from contamination. All end pieces are supplied with appropriate mounting screws.

Ordering example:

2x LWRM 9400

2x LWRV 9400

2x LWHW 15x358

4x LWERM 9



LWRM / LWRV precision rail guides

Dimensional drawing

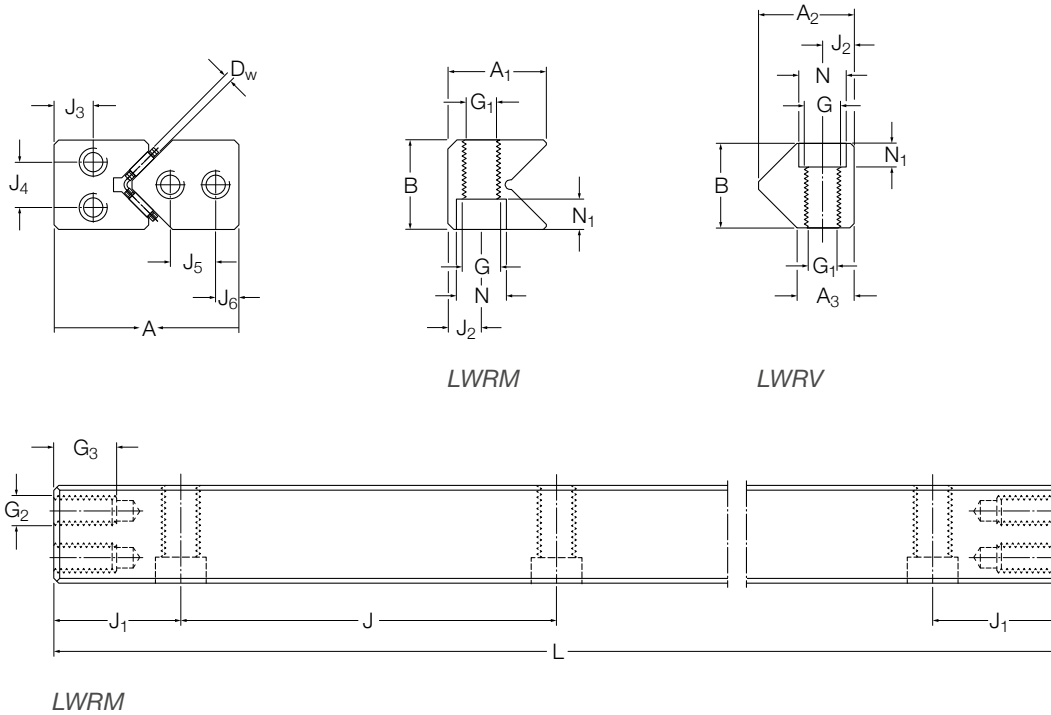

Technical data

Designation ¹⁾	Dimensions						Weight kg/m	Mounting holes				End face holes									
	A mm	B mm	A ₁	A ₂	A ₃	D _w		J mm	J ₁	J _{1min}	J ₂	G mm	G ₁	N	N ₁	J ₃ mm	J ₄	J ₅	J ₆	G ₂ mm	G ₃ mm
LWRM 6	31	15	16,5			2	1,48	50	25	20	6	M 6	5,2	9,5	5,2	8,5	7			M 3	6
LWRV 6	31	15		17,8	10,8	2	1,61	50	25	20	6	M 6	5,2	9,5	5,2		7	6		M 3	6
LWRM 9	44	22	23,1			2	3,14	100	50	20	9	M 8	6,8	10,5	6,2	10	11			M 5	8
LWRV 9	44	22		26,9	16,6	2	3,71	100	50	20	9	M 8	6,8	10,5	6,2		10	6		M 5	8

¹⁾ Sizes LWRM/LWRV 12 and 15 are available with delivery time on request.

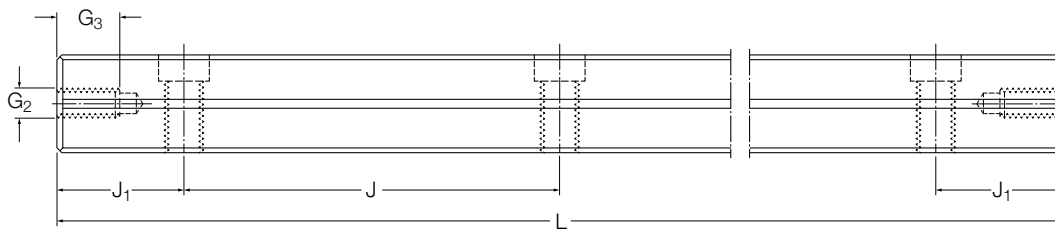

LWRV

Available lengths ¹⁾														Maximum rail length
100	150	200	250	300	350	400	500	600	700	800	900	1 000		
L														mm
mm														
●	●	●	●	●	○	●	○	○	○					1 000
●	●	●	●	●	○	●	○	○	○					1 000
		●		●		●	●	○	○	○	○	○	○	1 700
		●		●		●	●	○	○	○	○	○	○	1 700

¹⁾ Other rail lengths are available on request but new J₁ dimension has to be calculated as described in **chapter 4.1.7**.

● Prompt delivery

○ Delivery time on request

Needle roller assemblies

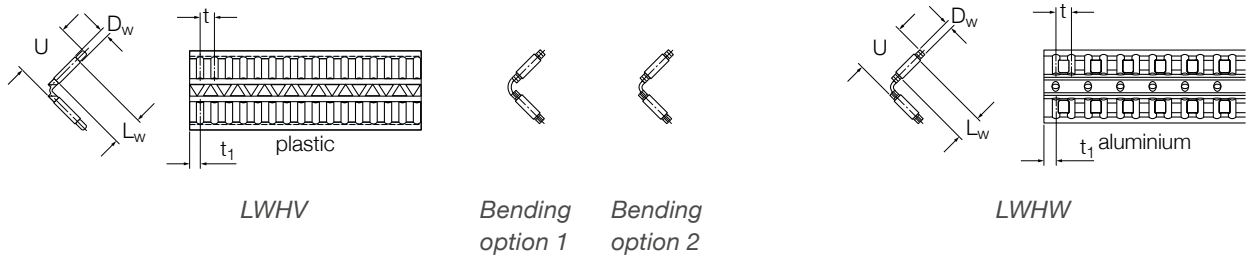

Designation	Dimensions					Load ratings for a cage with 2 rows of 10 needle rollers		Maximum cage length	Weight	Bending option	Appropriate rail guide
	D _w mm	L _w	U	t	t ¹	dynamic C ¹⁰ N	static C ^{0 10}				
-	-	-	-	-	-	-	-	mm	g/m	-	-
LWHV 10	2	4,8	10	3,75	2,7	10 400	25 500	50 000	76	1	LWRM 6/LWRV 6
LWHW 10	2	4,8	10	4	2,7	10 400	25 500	2 000	105	-	LWRM 6/LWRV 6
LWHV 15	2	7,8	15	3,75	2,7	16 300	45 000	50 000	120	2	LWRM 9/LWRV 9
LWHW 15	2	6,8	15	4,5	3,5	14 600	42 500	2 000	138	-	LWRM 9/LWRV 9

LWM / LWV end pieces

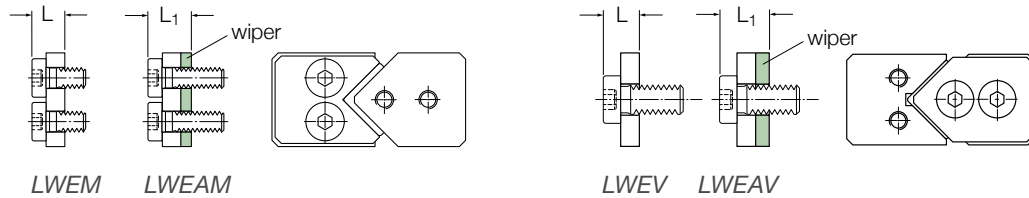

Designation	Dimensions	Attachment screw	Appropriate rail guide	Material of wiper	
					End pieces
-	-	-	-	-	
LWERM 6	4	M 3	LWRM 6	-	
LWERV 6	4	M 3	LWRM 6	-	
	LWEARM 6	6	M 3	LWRM 6	TPC-ET
	LWEARV 6	6	M 3	LWRM 6	TPC-ET
LWERM 9	6,5	M 5	LWRM 9	-	
LWERM 9	6,5	M 5	LWRM 9	-	
	LWEARM 9	8,5	M 5	LWRM 9	TPC-ET
	LWEARM 9	8,5	M 5	LWRM 9	TPC-ET

3.6 LWM / LWV

Rail guides

LWM/LWV rail guides enable linear guiding systems to be designed for heavy loads and with maximum rigidity. The internal geometry is identical with that of the Modular Range rails of the LWRM/LWRV series. As the same needle roller assembly is used, the load ratings are also the same. The external dimensions of the LWM/LWV rail guides differ slightly from those of the LWRM/LWRV Modular Range dimensions. LWM/LWV rail guides are widely used, especially in the machine tool industry. As standard, they are supplied with mounting holes of type 15 (through hole with counter bore), see drawing next page.

If mounting holes with thread G are requested, 2 options are offered:

- hole type 13, corresponding threaded inserts are glued into the rail.
- hole type 03, directly-machined threads, are available with delivery time on request.

For new designs, LWRM/LWRV rail guides are recommended, and offer the advantage of being interchangeable with other rail guides of the Modular Range.

Rolling element assemblies

LWHW needle roller assemblies comprise an aluminium cage with needle rollers arranged at right angles to each other. The needle rollers are retained by the cage. LWHV needle roller assemblies, consisting of a plastic cage with retained needle rollers, are available in size size LWHV10, LWHV15 and LWHV20.

End pieces for LWM/LWV rail guides

End pieces serve to prevent drift of the rolling element assemblies away from the loaded zone. Because of the design of LWM/LWV rail guides and the respective end pieces, only one rail, the M-shaped or the V-shaped, has to be equipped with end pieces. LWEAM and LWEAV end pieces have the addition of a plastic wiper with a sealing lip that keeps the raceway virtually free of dirt. All end pieces are supplied together with mounting screws.

Ordering example

2x LWM 4020200
 2x LWV 4020200
 2x LWHW 15x130
 4x LWEM 4020

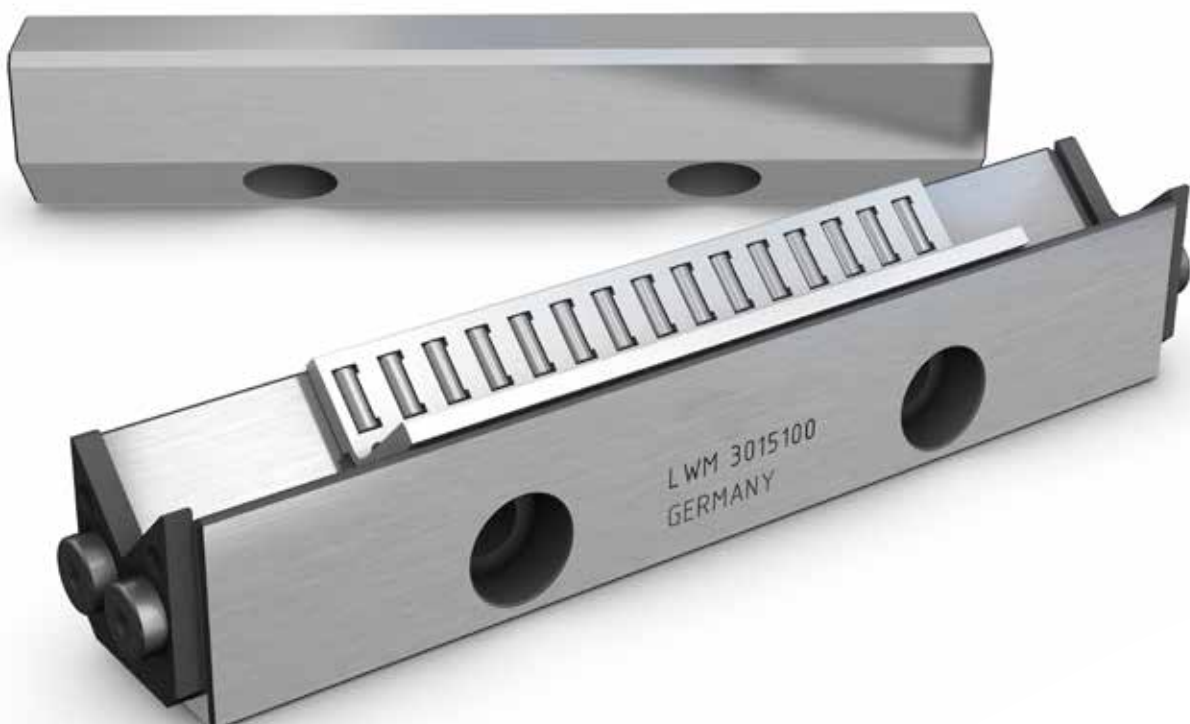

LWM / LWV precision rail guides

Dimensional drawing

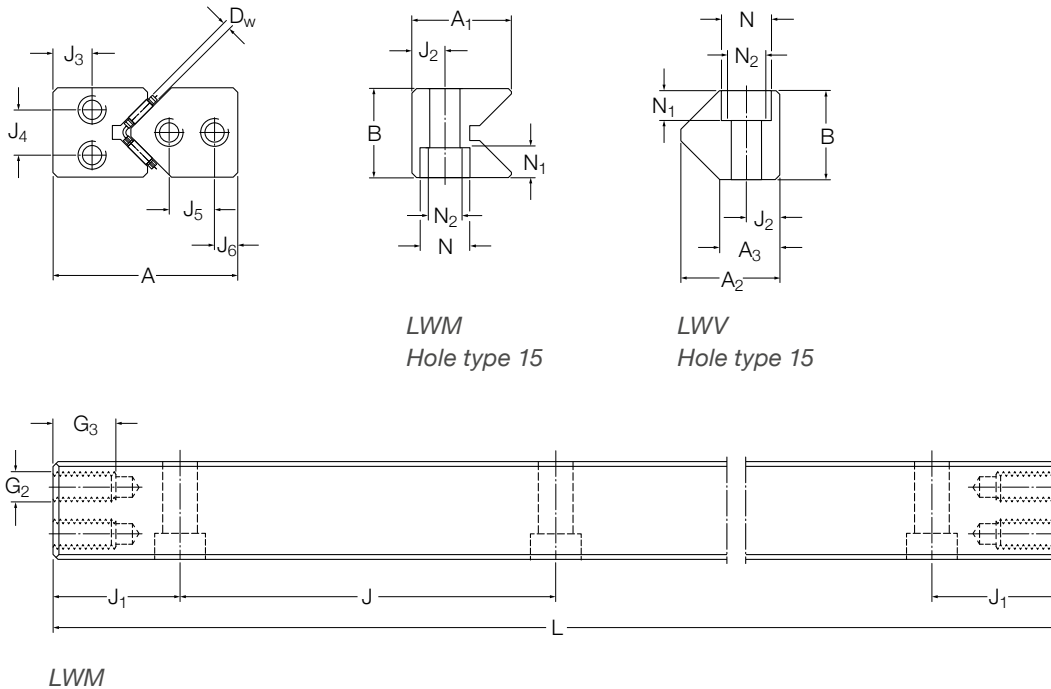

Technical data

Designation	Dimensions						Weight kg/m	Mounting holes					End face holes								
	A mm	B mm	A ₁	A ₂	A ₃	D _w		J ¹⁾ mm	J _{1min} ²⁾	J ₂	G mm	N mm	N ₁	N ₂	J ₃ mm	J ₄	J ₅	J ₆	G ₂ mm	G ₃ mm	G ₃ mm
LWM 3015	30	15	16			2	1,4	40	15	5,5	M 4	8,5	4,5	5,25	8	7			M 3	6	6
LWV 3015	30	15		17,2	10,5	2	1,57	40	15	5,5	M 4	8,5	4,5	5,25		7	5,5		M 3	6	6
LWM 4020	40	20	22,3			2	2,75	80	20	7,5	M 6	11,5	6,8	7,5	10	11			M 5	7	8
LWV 4020	40	20		22	13,5	2	2,74	80	20	7,5	M 6	11,5	6,8	7,5			10,5	5,5	M 5	7	8
LWM 5025	50	25	28			2	4,39	80	20	10	M 6	11,5	6,8	7,5	12	13			M 6	8	
LWV 5025	50	25		28	17	2	4,37	80	20	10	M 6	11,5	6,8	7,5			13	7	M 6	8	
LWM 6035	60	35	35			2,5	7,23	100	25	11	M 8	15	9	10	14	20			M 6	8	
LWV 6035	60	35		36	20	2,5	7,57	100	25	11	M 8	15	9	10			18	8	M 6	8	
LWM 7040	70	40	40			3	9,3	100	25	13	M 10	18,5	11	12,5	16	20			M 6	8	
LWV 7040	70	40		42	24	3	10,1	100	25	13	M 10	18,5	11	12,5			20	10	M 6	8	
LWM 8050	80	50	45			3,5	13,4	100	25	14	M 12	20	13	14	20	30			M 6	8	
LWV 8050	80	50		48,5	26	3,5	14,3	100	25	14	M 12	20	13	14			25	10	M 6	8	

¹⁾ For LWM/LWV 3015: If length L < 110 mm: J becomes = 35 mm if L < 65 mm ask for customized solution
 For LWM/LWV 4020 & 5025: If length L < 120 mm: J becomes = 50 mm if L < 90 mm ask for customized solution
 For LWM/LWV 6035, 7040 & 8050: If length L < 150 mm: J becomes = 50 mm if L < 100 mm ask for customized solution

²⁾ J₁ = (L-ΣJ)/2

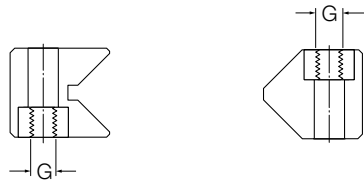

LWM
Hole type 13

LWV
Hole type 13

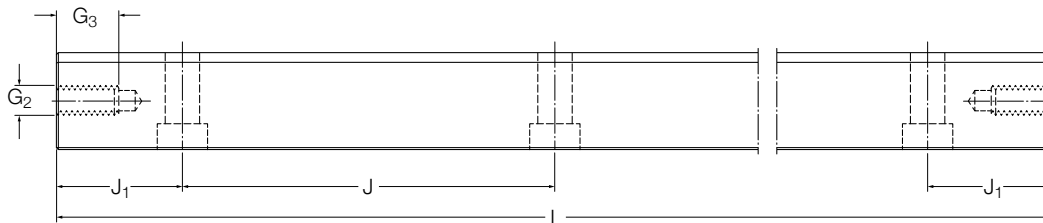

LWV



Available lengths ¹⁾											Maximum rail length
100	150	200	300	400	500	600	700	800	900	1 000	
L											mm
●	●	●	●	●	○	○					1 000
●	●	●	●	●	○	○					1 000
●	●	●	●	●	○	○	○	○	○	○	1 700
●	●	●	●	●	○	○	○	○	○	○	1 700
●		●	●	●	●	○	○	○	○	○	1 700
		○	○	○	○	○	○	○	○	○	1 700
		○	○	○	○	○	○	○	○	○	1 700
		○	○	○	○	○	○	○	○	○	1 700
		○	○	○	○	○	○	○	○	○	1 700
		○	○	○	○	○	○	○	○	○	1 700
		○	○	○	○	○	○	○	○	○	1 700

¹⁾ Other rail lengths available on request
 ● Prompt delivery
 ○ Delivery time on request

Needle roller assemblies

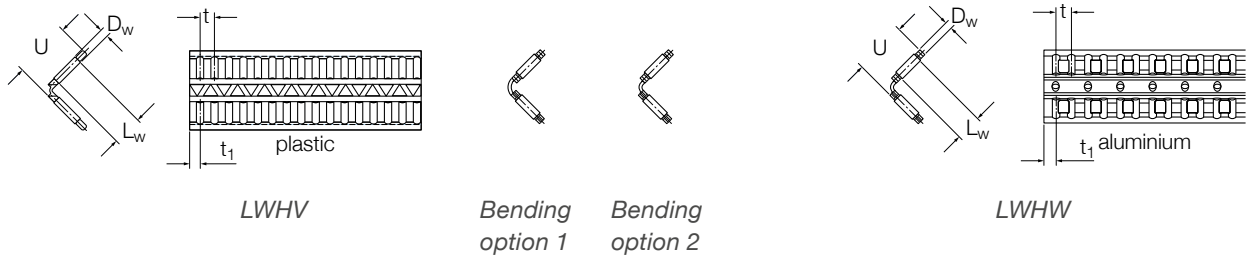

Designation	Dimensions					Load ratings for a cage with 2 rows of 10 needle rollers		Maximum cage length mm	Weight g/m	Bending option	Appropriate rail guide
	D _w mm	L _w	U	t	t ₁	dynamic C ₁₀ N	static C _{0.10}				
LWHV 10	2	4,8	10	3,75	2,7	10 400	25 500	50 000	76	1	LWM/LWV 3015
LWHW 10	2	4,8	10	4	2,7	10 400	25 500	2 000	105		LWM/LWV 3015
LWHV 15	2	7,8	15	3,75	2,7	16 300	45 000	50 000	120	1	LWM/LWV 4020
LWHV 15	2	7,8	15	3,75	2,7	16 300	45 000	50 000	120	2	LWM/LWV 5025
LWHW 15	2	6,8	15	4,5	3,5	14 600	42 500	2 000	138		LWM/LWV 4020 + 5025
LWHV 20	2,5	11,8	20	5	3,7	32 000	88 000	50 000	210	2	LWM/LWV 6035
LWHW 20	2,5	9,8	20	5,5	4	26 000	76 550	2 000	239		LWM/LWV 6035
LWHW 25	3	13,8	25	6	4,5	43 100	129 400	2 000	408		LWM/LWV 7040
LWHW 30	3,5	17,8	30	7	5	64 500	195 000	2 000	598		LWM/LWV 8050

LWM / LWV end pieces

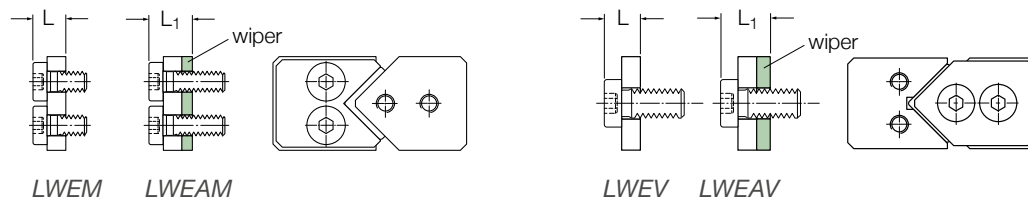

Designation	Dimensions	Attachment screw	Appropriate rail guide	Material of wiper	
					L
End pieces	End pieces with wiper				
-	-	mm	-	-	
LWEM 3015	4	M 3	LWM 3015		
LWEV 3015	4	M 3	LWV 3015		
	LWEAM 3015	6	M 3	LWM 3015	TPC-ET
	LWEAV 3015	6	M 3	LWV 3015	TPC-ET
LWEM 4020	6,5	M 5	LWM 4020		
LWEV 4020	6,5	M 5	LWV 4020		
	LWEAM 4020	8,5	M 5	LWM 4020	TPC-ET
	LWEAV 4020	8,5	M 5	LWV 4020	TPC-ET
LWEM/LWEV 5025 to 8050	7	M 6	LWM / LWV 5025 to 8050		
	LWEAM/LWEAV 5025 to 8050	9	M 6	LWM / LWV 5025 to 8050	TPC-ET

3.7 LWM / LWV ACSZ

Rail guides

LWM / LWV ACSZ rail guides are identical to LWM / LWV rail guides, but designed for use with anti-creeping LWHW ACSZ cages. For this purpose, both rails are equipped with gear racks made of steel. The cage carries two steel control gears that are always in mesh with the racks during operation, and help to ensure the right position of the rolling element assembly. As standard, the rails are equipped with gear racks over the full rail length (↳ [chapter 1.3](#)).

Rolling element assemblies

In principle, LWHW ACSZ cages are the same as LWHW cages, but LWHW ACSZ needle roller assemblies incorporate two steel control gears located at the centre of the cage. The load carrying capacity of LWHW ACSZ needle roller assemblies is also identical with that of LWHW standard needle roller assemblies. ACSZ does not result in additional cage length. LWHW ACSZ needle roller assemblies comprise an aluminium cage with retained needle rollers.

End pieces

Generally, end pieces are not needed for LWM / LWV ACSZ rail guides, since cage-creeping is prevented by the ACSZ. For production reasons, the tapped holes on the rail's end face are standard, and most end pieces, as for LWM / LWV rail guides, can be used with the exception of LWEAV. If tapped holes on the end face are not required, the rails should be ordered with option "E1".

Ordering example

2x LWM 6035300 ACSZ

2x LWV 6035300 ACSZ

2x LWHW 20x220 ACSZ



LWM / LWV ACSZ precision rail guides

Dimensional drawing

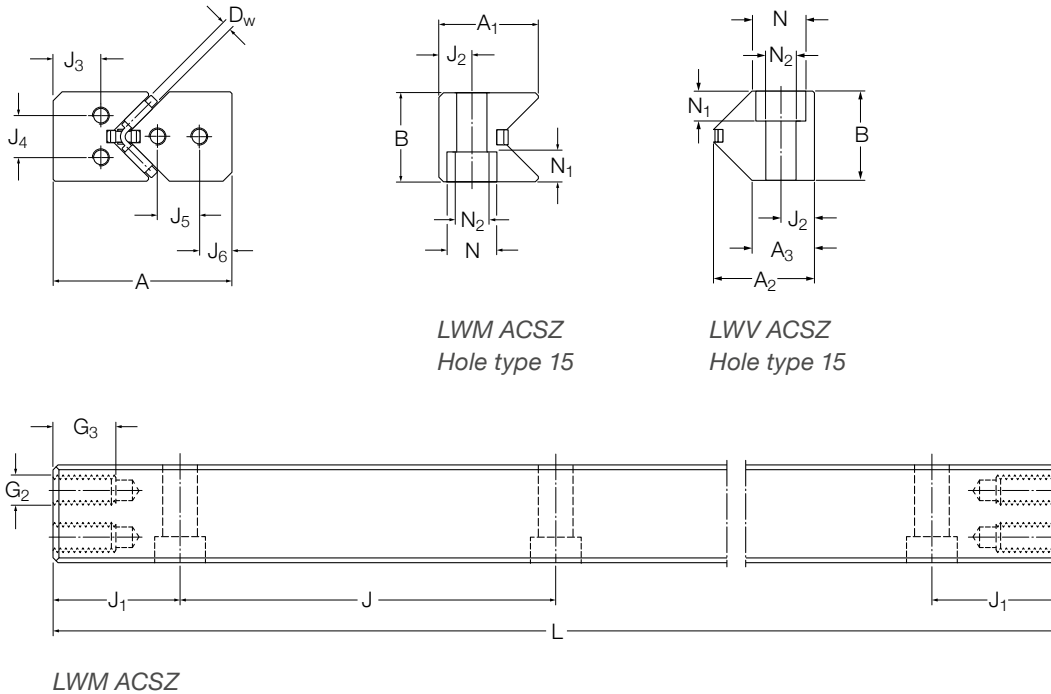

Technical data

Designation	Dimensions						Weight kg/m	Mounting holes					End face holes							
	A mm	B mm	A ₁	A ₂	A ₃	D _w		J ¹⁾ mm	J _{1 min} ²⁾	J ₂	G -	N mm	N ₁	N ₂	J ₃ mm	J ₄	J ₅	J ₆	G ₂ -	G ₃ mm
LWM 3015 ACSZ	30	15	16			2	1,4	40	15	5,5	M 4	8,5	4,5	5,25	8	7			M 3	6
LWV 3015 ACSZ	30	15		17,2	10,5	2	1,6	40	15	5,5	M 4	8,5	4,5	5,25		7	5,5		M 3	6
LWM 4020 ACSZ	40	20	22,3			2	2,8	80	20	7,5	M 6	11,5	6,8	7,5	10	11			M 5	7
LWV 4020 ACSZ	40	20		22	13,5	2	2,8	80	20	7,5	M 6	11,5	6,8	7,5			10,5	5,5	M 5	7
LWM 5025 ACSZ	50	25	28			2	4,5	80	20	10	M 6	11,5	6,8	7,5	12	13			M 6	8
LWV 5025 ACSZ	50	25		28	17	2	4,4	80	20	10	M 6	11,5	6,8	7,5			13	7	M 6	8
LWM 6035 ACSZ	60	35	35			2,5	7,3	100	25	11	M 8	15	9	10	14	20			M 6	8
LWV 6035 ACSZ	60	35		36	20	2,5	7,6	100	25	11	M 8	15	9	10			18	8	M 6	8
LWM 7040 ACSZ	70	40	40			3	9,4	100	25	13	M 10	18,5	11	12,5	16	20			M 6	8
LWV 7040 ACSZ	70	40		42	24	3	10,2	100	25	13	M 10	18,5	11	12,5			20	10	M 6	8
LWM 8050 ACSZ	80	50	45			3,5	13,5	100	25	14	M 12	20	13	14	20	30			M 6	8
LWV 8050 ACSZ	80	50		48,5	26	3,5	14,4	100	25	14	M 12	20	13	14			25	10	M 6	8

¹⁾ For LWM/LWV 3015: If length L < 110 mm: J becomes = 35 mm if L < 65 mm ask for customized solution
 For LWM/LWV 4020 & 5025: If length L < 120 mm: J becomes = 50 mm if L < 90 mm ask for customized solution
 For LWM/LWV 6035, 7040 & 8050: If length L < 150 mm: J becomes 0 50 mm if L < 100 mm ask for customized solution
²⁾ J₁ = (L - ΣJ) / 2

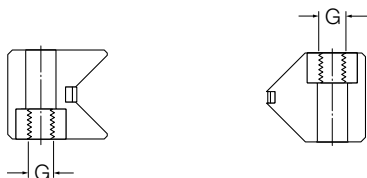

LWM ACSZ
Hole type 13

LWV ACSZ
Hole type 13

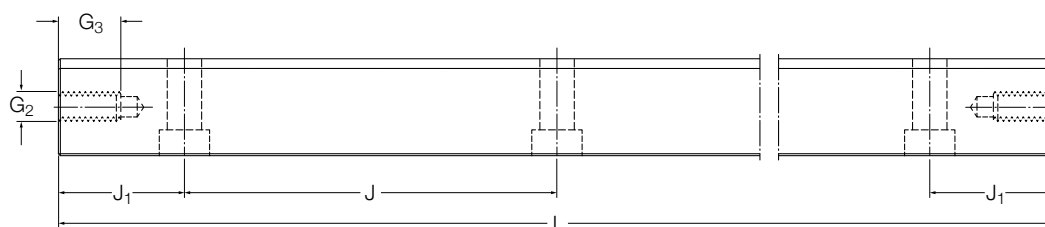

LWV ACSZ



Available lengths ¹⁾											Maximum rail length
100	150	200	300	400	500	600	700	800	900	1 000	
L											mm
○	○	○	○	○	○	○					1 000
○	○	○	○	○	○	○					1 000
○	○	○	○	○	○	○	○	○	○	○	1 700
○	○	○	○	○	○	○	○	○	○	○	1 700
○		○	○	○	○	○	○	○	○	○	1 700
		○	○	○	○	○	○	○	○	○	1 700
		○	○	○	○	○	○	○	○	○	1 700
		○	○	○	○	○	○	○	○	○	1 700
		○	○	○	○	○	○	○	○	○	1 700
		○	○	○	○	○	○	○	○	○	1 700
		○	○	○	○	○	○	○	○	○	1 700

¹⁾ Other rail lengths available on request
 ● Prompt delivery
 ○ Delivery time on request

Needle roller assemblies

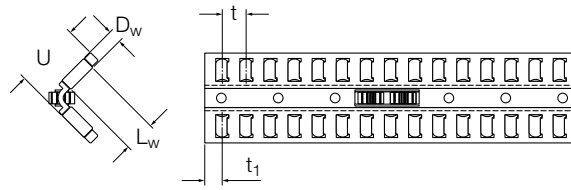

LWHW ACSZ

Designation	Dimensions						Load ratings for a cage with 2 rows of 10 needle rollers		Maximum cage length mm	Weight g/m	Appropriate rail guide
	D _w mm	L _w	U	t	t ₁	t ₂	dynamic C ₁₀ N	static C _{0.10}			
LWHW 10 ACSZ	2	4,8	10	4	2,7	0,7	10 400	25 500	2 000	106	LWM/LWV 3015 ACSZ
LWHW 15 ACSZ	2	6,8	15	4,5	3,5	0,8	14 600	42 500	2 000	139	LWM/LWV 4020 + 5025 ACSZ
LWHW 20 ACSZ	2,5	9,8	20	5,5	4	0,8	26 000	76 550	2 000	240	LWM/LWV 6035 ACSZ
LWHW 25 ACSZ	3	13,8	25	6	4,5	1,1	43 100	129 400	2 000	412	LWM/LWV 7040 ACSZ
LWHW 30 ACSZ	3,5	17,8	30	7	5	1,1	64 500	195 000	2 000	602	LWM/LWV 8050 ACSZ

LWM / LWV ACSZ end pieces

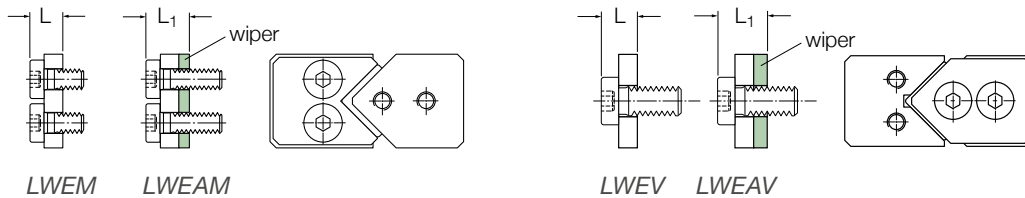

Designation	End pieces	End pieces with wiper	Dimensions		Attachment screw DIN 7984	Appropriate rail guide	Material of wiper
			L	L ₁			
			mm		-	-	
LWEM 3015			4		M 3	LWM 3015 ACSZ	
LWEV 3015			4		M 3	LWV 3015 ACSZ	
		LWEAM 3015		6	M 3	LWM 3015 ACSZ	TPC-ET
LWEM 4020			6,5		M 5	LWM 4020 ACSZ	
LWEV 4020			6,5		M 5	LWV 4020 ACSZ	
		LWEAM 4020		8,5	M 5	LWM 4020 ACSZ	TPC-ET
		LWEM/LWEV 5025 to 8050	7		M 6	LWM / LWV 5025 to 8050 ACSZ	
		LWEAM 5025 to 8050		9	M 6	LWM / LWV 5025 to 8050 ACSZ	TPC-ET

3.8 LWRPM / LWRPV

Rail guides

LWRPM/LWRPV rail guides are linear guides for limited travel, fitted with Turcite-B slide coating. Based on PTFE, this material is self-lubricating and offers excellent sliding properties. The coating is bonded to the non-hardened LWRPM rail and subsequently ground to size. Separate ordering of the slide coating is not required. The LWRPV rail is hardened and ground. In order to avoid damage to the sliding surface of the LWRPM rail, the LWRPV rail has a lead-in radius as standard. They are offered in precision class P10 only.

LWRPM/LWRPV rail guides should be used where rail guides with rolling element assemblies are unsuitable due to external influences, for example, extremely short strokes, high impact loads or dusty environment. The mounting and interface dimensions of the LWRPM/LWRPV rail guides conform to those of all the Ewellix Modular Range rail guides included in this cata-

logue. More details can be found in **chapter 2.7**.

LWRPM/LWRPV rail guides are characterized by:

- Stick-slip-free operation.
- Smooth running.
- Good emergency running properties.
- Low wear and high reliability.
- Resistance to contamination.
- Excellent vibration damping properties.

End pieces

LWRPM/LWRPV rail guides normally do not require end pieces. For this reason, tapped holes on the end faces are also unnecessary. However, for production reasons, LWRPV rail guides will, in certain cases, be supplied with tapped holes.

Ordering example:

2 × LWRPM 6300

2 × LWRPV 6300

LWRPM / LWRPV Slide coating

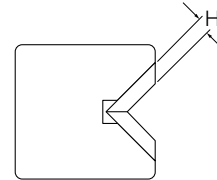

Designation ¹⁾	Dimensions	Load capacity ²⁾
Rail guide	H mm	C N / 100 mm
LWRPM 3	0,7	300
LWRPM 6	1,7	700
LWRPM 9	1,7	1 200

¹⁾ The slide coating is an integral part of the LWRPM rail and does not have to be ordered separately.

²⁾ For a surface loading of approx. 1 N/mm² (momentary loads of up to 6 N/mm² are permissible).

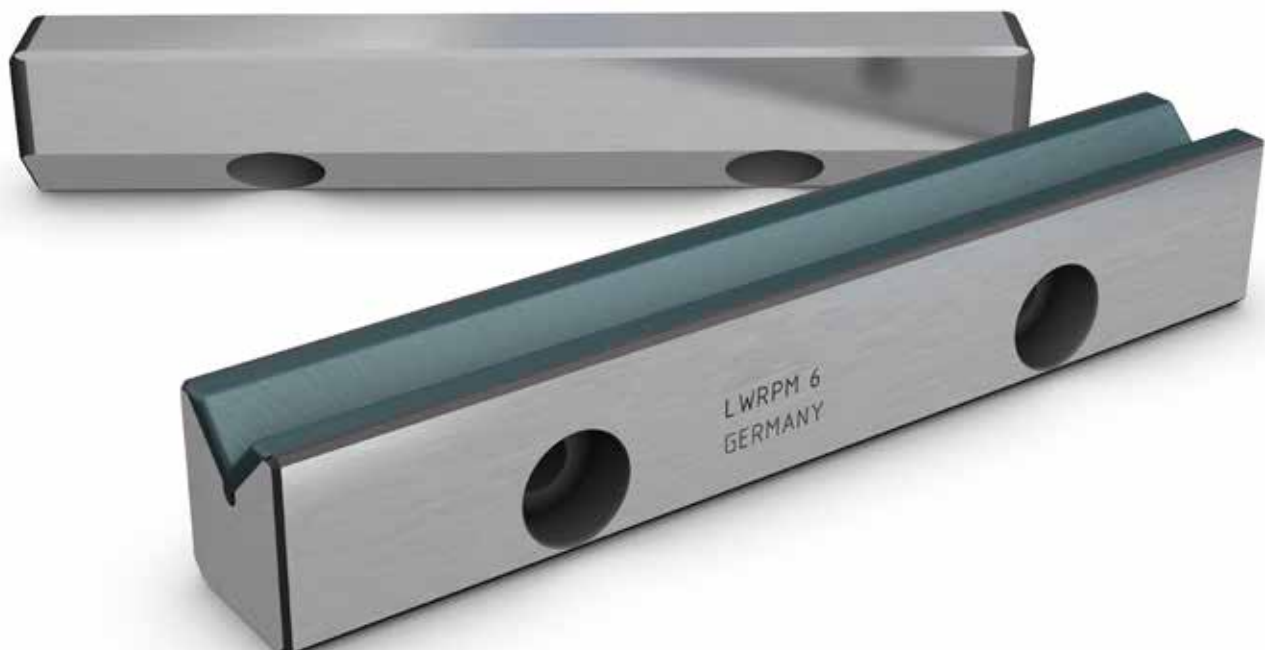

LWRPM / LWRPV precision rail guides

Dimensional drawing

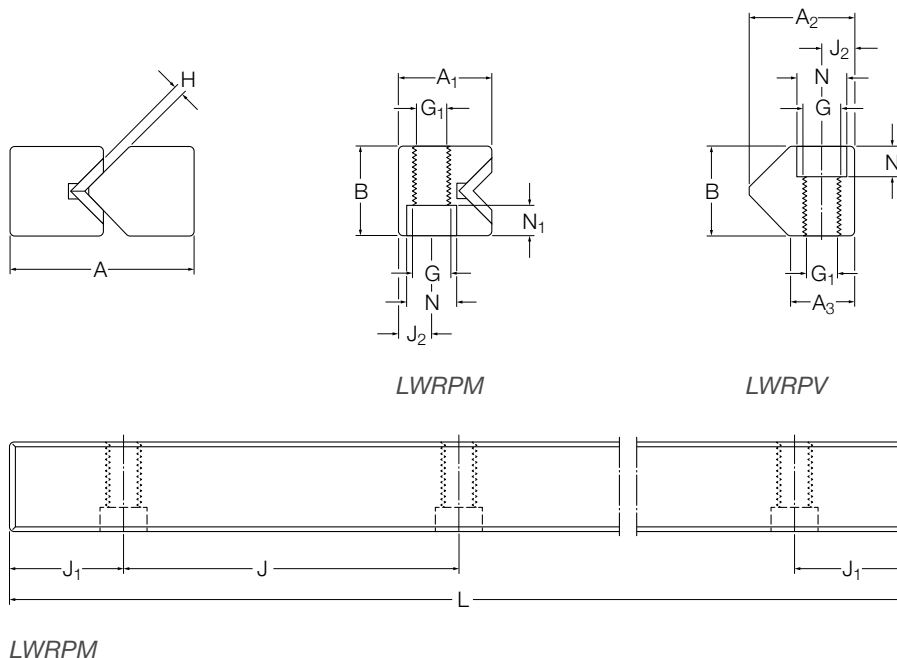

Technical data

Designation ¹⁾	Dimensions					Weight kg/m	Mounting holes							
	A mm	B	A ₁	A ₂	A ₃		J mm	J ₁	J _{1 min} ²⁾	J ₂	G -	G ₁ mm	N	N ₁
LWRPM 3	18	8	9,5			0,49	25	12,5	12,5	3,5	M 4	3,3	6	3,2
LWRPV 3	18	8		9,6	6,45	0,48	25	12,5	12,5	3,5	M 4	3,3	6	3,2
LWRPM 6	31	15	16,6			1,6	50	25	20	6	M 6	5,2	9,5	5,2
LWRPV 6	31	15		17,8	10,8	1,61	50	25	20	6	M 6	5,2	9,5	5,2
LWRPM 9	44	22	23,1			3,35	100	50	20	9	M 8	6,8	10,5	6,2
LWRPV 9	44	22		26,9	16,6	3,71	100	50	20	9	M 8	6,8	10,5	6,2

¹⁾ Sizes LWRPM/LWRPV 12 and LWRPM/LWRPV 15 are available with delivery time on request.

²⁾ The LWRPM/LWRPV rails do not require end pieces, thus these rails can be equipped - on customer demand - with 1 additional mounting hole, if a certain condition is fulfilled. Please address your request by specifying length J₁ in ordering key. If this option is chosen, they aren't compatible with rails according to standard..

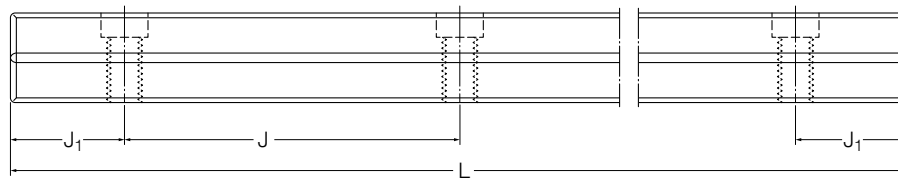

LWRPV

Available lengths ¹⁾																Maximum rail length						
50	75	100	125	150	175	200	225	250	275	300	350	400	450	500	550	600	650	700	800	900	1 000	
L																						mm
																						mm
●	●	●	●	●	●	●	○	○	○	○												400
●	●	●	●	●	●	●	○	○	○	○												400
	○	●		●		●		●		●	○	○	○	○	○	○	○	○				1 200
		●		●		●		●		●	○	●	○	○	○	○	○	○				1 200
						●		●		●		●		●		○	○	○	○	○	○	1 700
						●		●		●		●		○		○	○	○	○	○	○	1 700

¹⁾ Other rail lengths are available on request but new J₁ dimension has to be calculated as described in **chapter 4.1.7, Calculation of J₁ dimension.**

- Prompt delivery
- Delivery time on request

3.9 Other products

As well as the standard product range, upon request Ewellix can offer additional rolling element assemblies and guide types, such as flat rail guides or wrap-around guides. Also, completely customized guides can be manufactured for applications that do not allow the use of standard products.

3.9.1 LWML / LWV

The LWML rail guide consists of a modified LWM rail guide with the addition of an integrated adjustment wedge (→ **chapter 4.1.10, fig. 6**). Used in conjunction with an LWV guide and a needle roller assembly, this provides a preload-adjustable guide system. Inclination of the wedge surface is 1,5%, so that a displacement of the wedge by 1 mm brings about a 15 µm alteration in the height. LWML rail guides are available in classes P10 and P5. When ordering, it should be specified whether the countersinks are on the right-hand or left-hand side. Please contact Ewellix for details.

3.9.2 LWN / LWO

LWN/LWO rail guides differ from the LWM/LWV rail guides only in height, width and attachment holes. The internal geometry of the two rail guide series is the same and their load ratings are identical. LWN/LWO rail guides are available in precision classes P10, P5 and P2.

3.9.3 LWJ / LWS flat rail guides

LWJ/LWS flat rail guides are used in conjunction with LWRM/LWRV, LWM/LWV or LWN/LWO rail guides as non-locating linear guides. They are incorporated in floating slides. LWJ/LWS flat rail guides, as well as the appropriate rolling element assemblies and end pieces, are available on request.

Customized precision rail guides

With the knowledge and manufacturing capabilities existing within Ewellix, it is possible for Ewellix to produce completely customized guides or other precision parts.

3.10 GCL / GCLA standard slides

GCL and GCLA are pre-assembled slides made of steel or aluminium, and crossed roller precision rail guides for applications that require maximum accuracy and rigidity. Typical applications are factory automation, printing, packaging and general machinery.

GCL and GCLA standard slides are available with delivery time on request.

Advantages:

- Top and base plate of a GCLA are made of aluminium or for GCL made of
 - blackened steel (up to size 3) or
 - cast iron (starting with size 6).
 On customer request the top and base plate could be made from stainless steel 1.4305 or Nickel plated steel.
- Standard patterns of attachment holes for easy mounting.
- Upper and lower mounting surfaces are ground for high running accuracy.
- Reference edge parallel to the slide axis (opposite of preload set screws).
- Internal end stops to limit the stroke.
- Very low friction of the rail guides.
- Relubrication identical with precision rail guides, (↳ [chapter 4.3](#)).

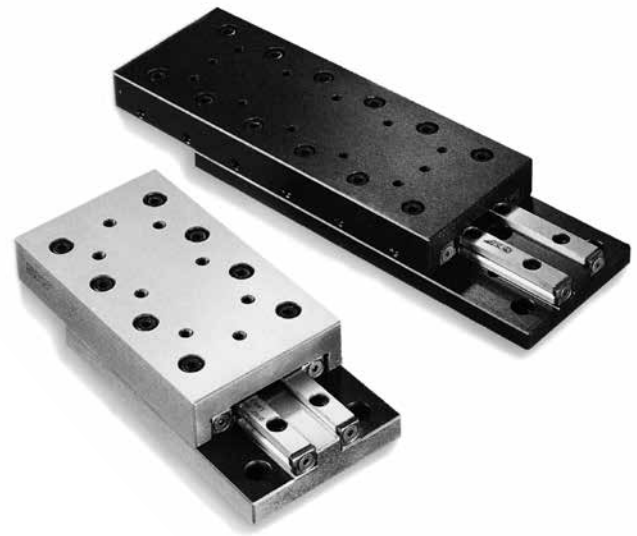

GCL / GCLA data

Slides	
GCL / GCLA 2	LWRB 2 with LWJK 2
GCL / GCLA 3	LWR 3 with LWAK 3
GCL / GCLA 6	LWR 6 with LWAL 6
GCL / GCLA 9	LWR 9 with LWAL 9
	Optional with anti-creeping solution ACS/ACSM and / or coating
Operating temperature	-30 to +80 °C
Maximum speed	2 m/s
Maximum acceleration	25 m/s ²
Friction coefficient	0,003–0,005 (with normal, light lubrication)
Preload	Preloaded in factory with standard values
Precision class	P10 (other precision class with delivery time on request)
Lubrication	Lightly greased on assembly
Optional	Customized solutions possible

GCL / GCLA running accuracy

	Stroke (mm)	25	50	100	200	300
GCL	Straightness height T_z	2 µm	2 µm	3 µm	3 µm	4 µm
	Straightness side T_y	2 µm	2 µm	2 µm	3 µm	3 µm
GCLA	Straightness height T_z	4 µm	4 µm	6 µm	7 µm	8 µm
	Straightness side T_y	4 µm	4 µm	5 µm	6 µm	7 µm

GCL

Dimensional drawing

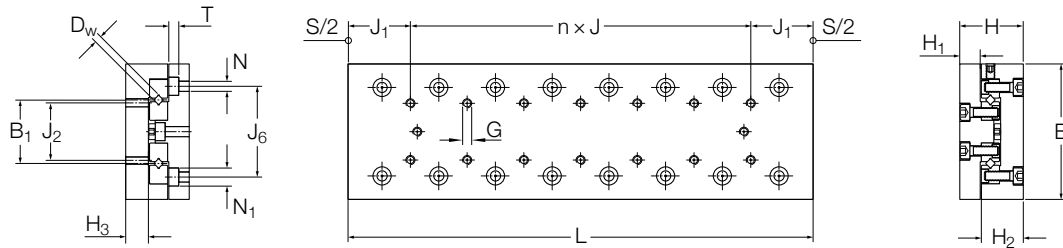

Technical data

Designation ¹⁾	Dimensions			Stroke ²⁾										
	-0,2 -0,4	±0,1		S ₁	S ₂	B ₁	D _w	G	H ₁ mm	H ₂	H ₃	n x J	J ₁	J ₂
-	B mm	H	L											
GCL 2030	40	21	35	18		18	2	M3	6,5	14	7,5		17,5	15
GCL 2045			50	30								1 x 15		
GCL 2060			65	40	46							2 x 15		
GCL 2075			80	50	60							3 x 15		
GCL 2090			95	60	75							4 x 15		
GCL 2105			110	70	90							5 x 15		
GCL 2120			125	80	105							6 x 15		
GCL 3050	60	28	55	30		28	3	M4	9	18,5	10		27,5	25
GCL 3075			80	45	55							1 x 25		
GCL 3100			105	60	80							2 x 25		
GCL 3125			130	75	105							3 x 25		
GCL 3150			155	90	130							4 x 25		
GCL 3175			180	105	155							5 x 25		
GCL 3200			205	130	180							6 x 25		
GCL 6100	100	45	110	60	70	45	6	M6	13	31	15,5		55	50
GCL 6150			160	95	120							1 x 50		
GCL 6200			210	130	170							2 x 50		
GCL 6250			260	165	220							3 x 50		
GCL 6300			310	200	270							4 x 50		
GCL 6400			410	280	370							6 x 50		
GCL 9200	145	60	210	130		72	9	M8	16	43	20,5		105	80
GCL 9300			310	180								1 x 100		
GCL 9400			410	350								2 x 100		
GCL 9500			510	450								3 x 100		

¹⁾ Delivery time generally on request

²⁾ S₁ standard stroke order designation, e.g. GCL 2060,

S₂ extended stroke order designation, e.g. GCL 2060/L

³⁾ Take chapter 2.3.2, in consideration.

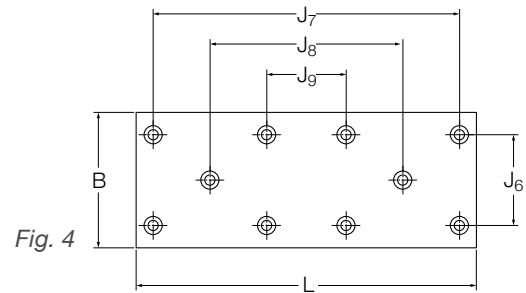
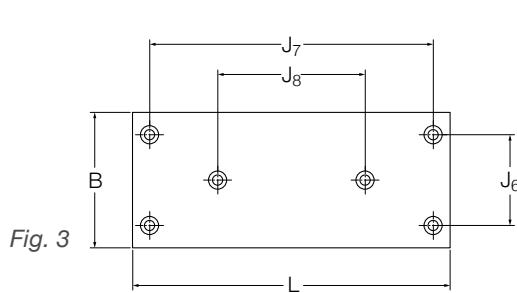
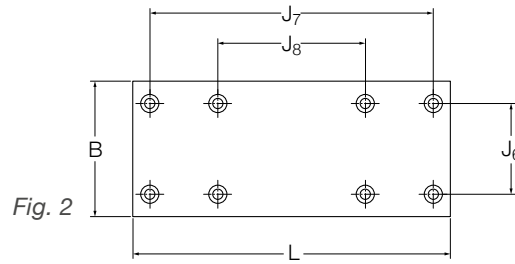
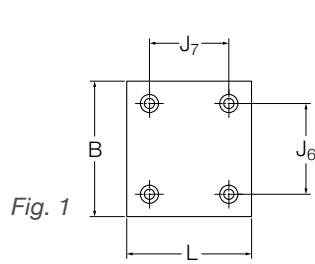

J ₆ mm	J ₇	J ₈	J ₉	Fig.	N	N ₁	T	Effective dynamic load ratings of the slide		Effective static load ratings of the slide ³⁾		Weight kg
								with S ₁ C _{eff slide} N	with S ₂	with S ₁ C _{0 eff slide} N	with S ₂	
30	25			1	3,4	6	3,4	394		360		0,18
	40			1				499		504		0,26
	55			1				640	594	720	648	0,34
	70	40		2				769	684	936	792	0,42
	85	55		2				850	769	1 080	936	0,5
	100	70		2				966	850	1 296	1 080	0,58
	115	85		2				1 040	928	1 440	1 224	0,68
40	35			1	4,5	8	4,6	886		960		0,57
	60			1				1 320	1 216	1 600	1 440	0,8
	85			1				1 620	1 422	2 080	1 760	1
	110			1				1 997	1 716	2 720	2 240	1,3
	135	85		3				2 267	1 905	3 200	2 560	1,5
	160	110		3				2 613	2 178	3 840	3 040	1,7
	185	135	85	4				2 781	2 355	4 160	3 360	2
60	90			1	6,6	11	6,8	4 429	3 927	4 760	4 080	3,1
	140			1				6 301	5 388	7 480	6 120	4,5
	190	90		3				7 606	6 744	9 520	8 160	5,9
	240	140		3				9 253	8 026	12 240	10 200	7,2
	290	190		3				10 435	9 253	14 280	12 240	8,6
	390	290		3				13 060	11 202	19 040	15 640	11,4
90	100			1	9	15	9	15 659		16 470		11,8
	200			1				22 102		25 620		17,3
	300	100		3				23 324		27 450		22,8
	400	200		3				28 046		34 770		28,3

GCLA

Dimensional drawing

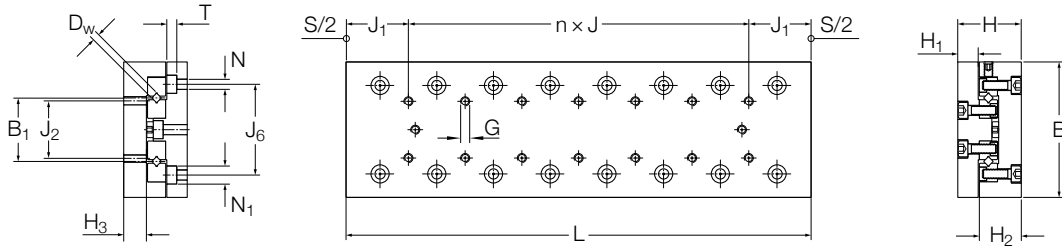

Technical data

Designation ¹⁾	Dimensions			Stroke ²⁾										
	-0,2 -0,4	±0,1		S ₁	S ₂	B ₁	D _w	G	H ₁ mm	H ₂	H ₃	n x J	J ₁	J ₂
-	B mm	H	L											
GCLA 2030	40	21	35	18		18	2	M3	6,5	14	7,5		17,5	15
GCLA 2045			50	30								1 x 15		
GCLA 2060			65	40	46							2 x 15		
GCLA 2075			80	50	60							3 x 15		
GCLA 2090			95	60	75							4 x 15		
GCLA 2105			110	70	90							5 x 15		
GCLA 2120			125	80	105							6 x 15		
GCLA 3050	60	25	55	30		28	3	M4	8	16,5	8		27,5	25
GCLA 3075			80	45	55							1 x 25		
GCLA 3100			105	60	80							2 x 25		
GCLA 3125			130	75	105							3 x 25		
GCLA 3150			155	90	130							4 x 25		
GCLA 3175			180	105	155							5 x 25		
GCLA 3200			205	130	180							6 x 25		
GCLA 6100	100	40	110	60	70	45	6	M6	11,5	28	12,5		55	50
GCLA 6150			160	95	120							1 x 50		
GCLA 6200			210	130	170							2 x 50		
GCLA 6250			260	165	220							3 x 50		
GCLA 6300			310	200	270							4 x 50		
GCLA 6400			410	280	370							6 x 50		
GCLA 9200	145	50	210	130		72	9	M8	14	35	12,5		105	80
GCLA 9300			310	180								1 x 100		
GCLA 9400			410	350								2 x 100		
GCLA 9500			510	450								3 x 100		

¹⁾ Delivery time generally on request

²⁾ S₁ standard stroke order designation, e.g. GCLA 2060.

S₂ extended stroke order designation, e.g. GCLA 2060/L

³⁾ Take chapter 2.3.2, in consideration.

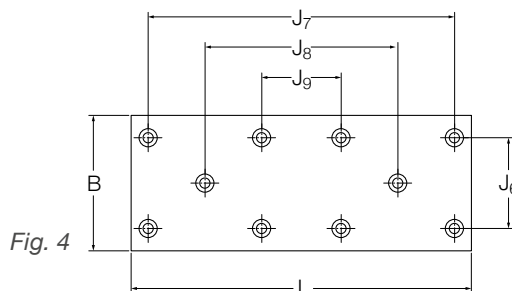
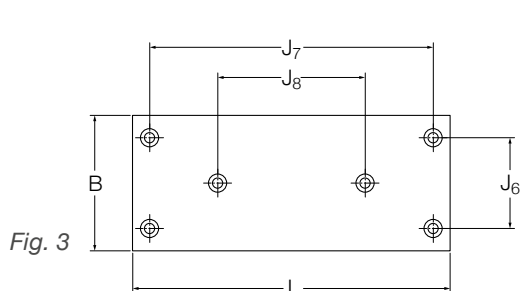
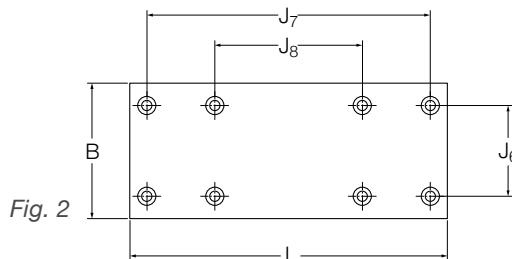
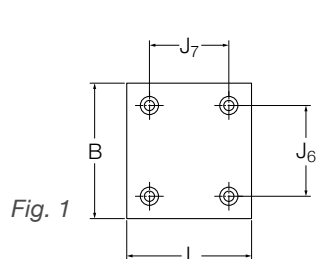

J ₆ mm	J ₇	J ₈	J ₉	Fig.	N	N ₁	T	Effective dynamic load ratings of the slide		Effective static load ratings of the slide ³⁾		Weight kg
								with S ₁ C _{eff slide} N	with S ₂	with S ₁ C _{0 eff slide} N	with S ₂	
30	25			1	3,4	6	3,4	394		360		0,11
	40			1				499		504		0,15
	55			1				640	594	720	648	0,19
	70	40		2				769	684	936	792	0,23
	85	55		2				850	769	1 080	936	0,27
	100	70		2				966	850	1 296	1 080	0,31
	115	85		2				1 040	928	1 440	1 224	0,35
40	35			1	4,5	8	4,6	886		960		0,29
	60			1				1 320	1 216	1 600	1 440	0,42
	85			1				1 620	1 422	2 080	1 760	0,55
	110			1				1 997	1 716	2 720	2 240	0,68
	135	85		3				2 267	1 905	3 200	2 560	0,81
	160	110		3				2 613	2 178	3 840	3 040	0,94
	185	135	85	4				2 781	2 355	4 160	3 360	1,1
60	90			1	6,6	11	6,8	4 429	3 927	4 760	4 080	1,5
	140			1				6 301	5 388	7 480	6 120	2,3
	190	90		3				7 606	6 744	9 520	8 160	3
	240	140		3				9 253	8 026	12 240	10 200	3,8
	290	190		3				10 435	9 253	14 280	12 240	4,5
	390	290		3				13 060	11 202	19 040	15 640	6
90	100			1	9	15	9	15 659		16 470		5,9
	200			1				22 102		25 620		8,7
	300	100		3				23 324		27 450		11,4
	400	200		3				28 046		34 770		14,2

3.11 LZM miniature slide

With the LZM miniature slide product range, Ewellix offers the ideal solution for linear motion applications with short strokes and compact boundary dimensions. The use of miniature slides has significantly increased in medical applications, measurement technologies and micro mechanics and assembly.

The various LZM miniature slide components are designed to meet the highest precision standards. LZM miniature slides feature high running accuracy and smooth motion, and are manufactured with all-stainless-steel components. The maximum tolerance of parallelism between the raceways and the mounting surface is 3 μm . Optimized hardness enables long service life and high performance within compact boundary dimensions.

Ease of installation is another positive feature of LZM miniature slides. Unlike crossed roller systems using 4 rails and 2 rolling element assemblies to be assembled on the production floor, the LZM miniature slide provides a complete slide that can simply be bolted into place without the use of precision devices to set preload.

Customized miniature slides are also possible, and Ewellix will modify existing designs to meet specific technical requirements. Wide versions of LZMs for higher torque loads, comparable with wide miniature profile rail guides LLMWS, can also be supplied on request.

Applications:

- Pneumatics
- Semi-conductor manufacturing
- Medical
- Micro- and electronics assembly
- Measurement applications
- Fibre optics

Advantages:

- Compact design
- High load capacity
- Very good running accuracy
- Smooth running
- High rigidity
- Easy assembly

Ordering example

- LZMHS 9 – 26
(P5, T0 as standard – no need to specify)
- LZMHS 9 – 26 T2 P1



LZM data

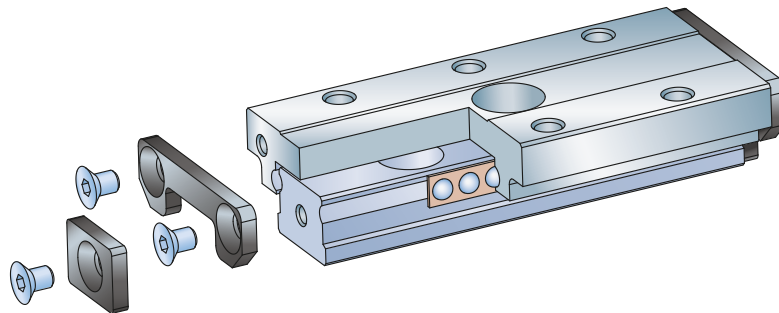

Technical data

Design	Four point contact with identical load angles
Standard range	Four sizes: 7, 9, 12 and 15
Optional range	Wide versions for 9, 12 and 15
Operating temperature	-20 up to +80 °C
Max. speed	3 m/s
Max. acceleration	80 m/s ² (for preloaded LZMs)
Preload classes	T0 = light clearance; Standard T1 = zero clearance to light preload T2 = preloaded
Precision classes	P5 = standard P1 = high
Lubrication	Slides are pre-lubricated with "Paraliq P460"

Material specifications

Carriage and rail	Steel 1.4034 / 1.4037
Balls	Steel 1.3541
End pieces	Plastic
Cage	Plastic

Dimensional tolerance of H

Precision class	mm
P5	+/-0,02
P1	+/-0,01

LZM miniature slides

Dimensional drawing

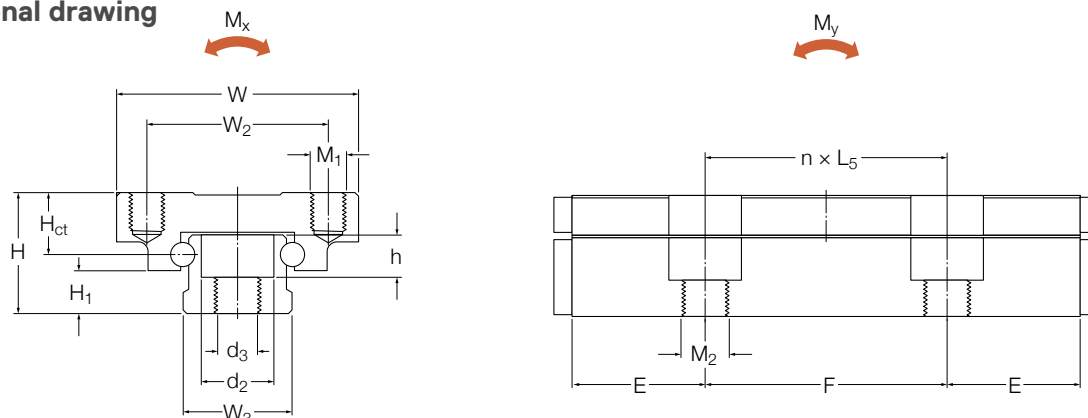

Technical data

Designation	Dimensions												Number of threads M_1
	L mm	L_1	L_2	L_4	$n \times L_5^{1)}$	W	W_2	W_3	H	H_1	$M_1 \times \text{depth}$		
LZM HS 7 - 26	26	5	8	29	-	17	12	7	8	2,35	M2 x 2,5	6	
LZM HS 7 - 34	34	5	8	37	0	17	12	7	8	2,35	M2 x 2,5	8	
LZM HS 7 - 50	50	5	8	53	30	17	12	7	8	2,35	M2 x 2,5	12	
LZM HS 7 - 66	66	5	8	69	30	17	12	7	8	2,35	M2 x 2,5	16	
LZM HS 9 - 32	32	9,5	13	35	-	20	15	9	10	3,55	M3 x 3	4	
LZM HS 9 - 42	42	8	13	45	0	20	15	9	10	3,55	M3 x 3	6	
LZM HS 9 - 55	55	8	13	58	20	20	15	9	10	3,55	M3 x 3	8	
LZM HS 9 - 81	81	8	13	84	2 x 20	20	15	9	10	3,55	M3 x 3	12	
LZM HS 9 - 94	94	8	13	97	3 x 20	20	15	9	10	3,55	M3 x 3	14	
LZM HS 12 - 37	37	11	15	40	-	27	20	12	13	4,7	M3 x 3,5	4	
LZM HS 12 - 51	51	10,5	15	54	0	27	20	12	13	4,7	M3 x 3,5	6	
LZM HS 12 - 66	66	10,5	15	69	25	27	20	12	13	4,7	M3 x 3,5	8	
LZM HS 12 - 96	96	10,5	15	99	50	27	20	12	13	4,7	M3 x 3,5	12	
LZM HS 12 - 126	126	10,5	15	129	3 x 25	27	20	12	13	4,7	M3 x 3,5	16	
LZM HS 15 - 52	52	16	20	56	-	32	25	15	16	6	M3 x 4	4	
LZM HS 15 - 85	85	12,5	20	89	0	32	25	15	16	6	M3 x 4	8	
LZM HS 15 - 105	105	12,5	20	109	40	32	25	15	16	6	M3 x 4	10	
LZM HS 15 - 165	165	12,5	20	169	80	32	25	15	16	6	M3 x 4	16	

¹⁾ - means no hole; $L_5 = 0$ means one hole in the centre

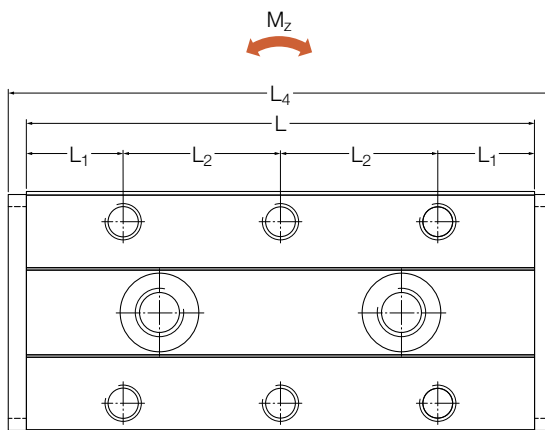

E mm	F	$d_3 \times d_2 \times h$	M_2 -	Number of threads M_2	Max. stroke mm	C N	C_0	M_{yCo} / M_{zCo} Nm	M_{xCo}	H_{ct} mm
5,5	15	2,5 × 4,5 × 2,5	M3	2	24	700	1 100	3,5	6	4,62
9,5	15	2,5 × 4,5 × 2,5	M3	2	34	900	1 400	5,5	7	4,62
10	15	2,5 × 4,5 × 2,5	M3	3	50	1 100	2 000	12	10	4,62
10,5	15	2,5 × 4,5 × 2,5	M3	4	66	1 400	2 700	21	14	4,62
6	20	3,5 × 6,5 × 3,5	M4	2	28	1 200	1 800	7	12	5,12
11	20	3,5 × 6,5 × 3,5	M4	2	40	1 400	2 100	11	15	5,12
7,5	20	3,5 × 6,5 × 3,5	M4	3	54	1 900	3 400	18	19	5,12
10,5	20	3,5 × 6,5 × 3,5	M4	4	78	2 500	4 900	43	29	5,12
7	20	3,5 × 6,5 × 3,5	M4	5	92	2 700	5 500	57	33	5,12
6	25	3,5 × 6,5 × 4,5	M4	2	32	2 200	3 300	11	21	6,5
13	25	3,5 × 6,5 × 4,5	M4	2	47	2 600	4 300	22	28	6,5
8	25	3,5 × 6,5 × 4,5	M4	3	62	3 000	5 300	36	36	6,5
10,5	25	3,5 × 6,5 × 4,5	M4	4	95	3 800	7 200	76	52	6,5
13	25	3,5 × 6,5 × 4,5	M4	5	122	4 700	9 700	131	68	6,5
6	40	3,5 × 6,5 × 4,5	M4	2	50	2 800	3 900	25	42	7,65
22,5	40	3,5 × 6,5 × 4,5	M4	2	80	4 600	7 800	73	70	7,65
12,5	40	3,5 × 6,5 × 4,5	M4	3	102	5 100	9 100	106	84	7,65
22,5	40	3,5 × 6,5 × 4,5	M4	4	162	7 300	15 000	264	131	7,65

4

Mounting Instruction and Manual

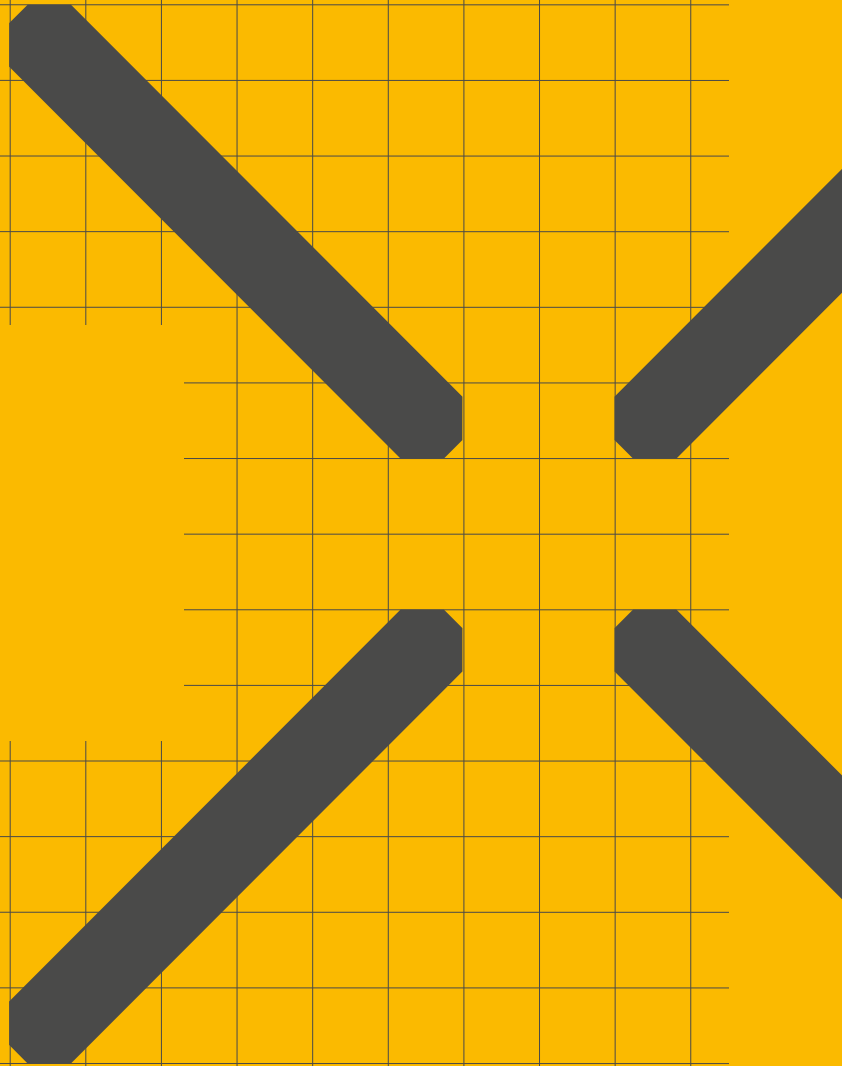

4.1 Design rules

4.1.1 Designated use

- Ewellix precision rail guide systems must only be used for linear movement of loads that do not give off emissions which could pose a danger to the system, and that do not overload the rail guides.
- Ewellix precision rail guide systems must not be used in outdoor, wet or explosive areas.
- End pieces must not be used as a mechanical stroke limitation of the rail guide system, as this can result in cage damage.

4.1.2 Typical mounting – clamped arrangement

The most common way to design a precision rail guide system is the clamped arrangement, as it has several advantages. Alternatively or for other designs the floating arrangement exists. Both versions are explained in greater detail in chapter 2.3.4.

4.1.3 Accuracy of mounting surfaces

An important prerequisite for correct performance of a rail guide system is accuracy of the mounting surfaces. The higher the demand for accuracy of the guides and for smooth, easy operation, the greater is the requirement for accuracy of form and position of the counterparts.

Values for surface roughness, perpendicularity and parallelism of the mounting surfaces are shown for each precision class in **fig. 1** and **table 1**. The values for perpendicularity are given in relation to the relevant height of the mounting surface. To ensure an even load distribution over the full length of the rolling element, the maximum difference in height of the mounting surfaces should not exceed Δh .

$$\Delta h = 0,1 \times B_1$$

where

Δh = maximum height deviation [μm]

B_1 = mean distance between rolling element assemblies [mm]

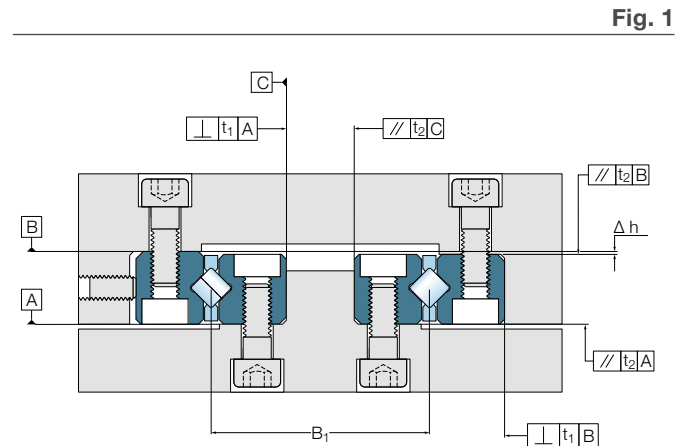

Fig. 1

Table 1

Accuracy of form for mounting surfaces

Characteristic	Symbol	Tolerance	Dimension	Permissible form-deviation for precision class		
				P10	P5	P2
Roughness R ^a	√		μm	1,6	0,8	0,2
Perpendicularity	⊥					
for crossed rollers and balls		t ₁	$\mu\text{m}/\text{mm}$	0,3	0,3	0,3
for needle rollers		t ₁	$\mu\text{m}/\text{mm}$	0,1	0,1	0,1
Parallelism for	//					
rail length ≤ 200 mm		t ₂	μm	3	2	1
rail length ≤ 500 mm		t ²	μm	6	4	2
rail length ≤ 1 000 mm		t ²	μm	12	7	3
rail length ≤ 1 600 mm		t ₂	μm	10	6	3



4.1.4 End pieces logic

Together with the different kinematics, also the end pieces have to be selected accordingly. **Table 2** shows the logic.

Table 2

End pieces logic

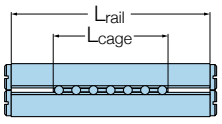
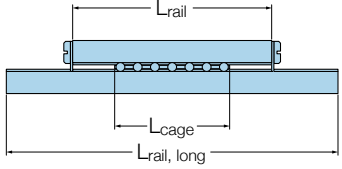
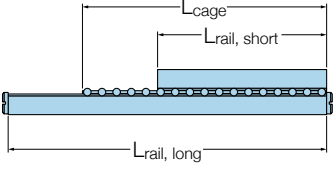
Description of kinematic		Not overrunning rail guide without wipers (Standard)	Rail guide with wipers		Overrunning rail guide without wipers	
						
Type of rail	Type of ACS		Long rail	Short rail	Long rail	Short rail
LWR LWRB LWRE	no	with end pieces	without end pieces	with end pieces and wipers	with end pieces	without end pieces
LWRE	ACS	end pieces not needed, but front face of rails equipped with mounting threads. So end pieces mountable by customer.	without end pieces	with end pieces and wipers	end pieces not needed, but front face of rails equipped with mounting threads. So end pieces mountable by customer.	without end pieces
LWRB LWRE	ACSM	without end pieces	without end pieces	with end pieces and wipers	without end pieces	without end pieces
LWM / V LWRM / V	no	with end pieces on one rail only (on M- or V-shaped rail)	without end pieces	with end pieces and wipers	with end pieces	without end pieces
LWM / V	ACSZ	end pieces not needed, but front face of rails equipped with mounting threads. So end pieces mountable by customer.	without end pieces	with end piece and wipers mounted at the rail with – M-shaped cross section: feasible – V-shaped cross section: not feasible	end pieces not needed, but front face of rails equipped with mounting threads. So end pieces mountable by customer.	without end pieces

Cannot be changed
 Can be changed on request

4.1.5 Chamfers on the precision rail guides

For the design of surrounding parts, the tolerance of the chamfer between the two reference surfaces of the precision rail guide must be taken into account. Value c depends on the rail width B (→ fig. 2).

- Rail width B ≤ 8 mm: c ≥ 0,3 mm
- Rail width B > 8 mm: c ≥ 0,9 mm

Fig. 2

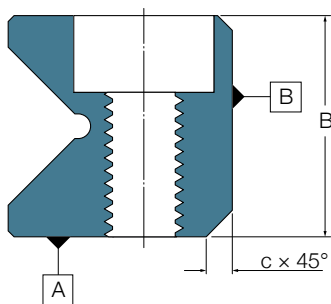

4.1.6 Tolerance of distance between mounting holes

The tolerance of distance between the mounting holes depends on the rail length L_{rail}. The values shown below are valid for all mounting holes along the rail. Rails with tighter tolerances for the distance between the holes can be supplied on request. For long rails, the use of special mounting screws (LWGD) is recommended (→ fig. 3).

- L_{rail} ≤ 300: t = 0,6 mm
- L_{rail} > 300: t = 0,0016 mm × L_{rail}

4.1.7 Calculation of J₁ dimension

Usually dimension J₁ is chosen symmetrically on both rail ends. If so, then the symmetrical dimension J₁ can be calculated with the following formula.

Thereby, the minimum value for J₁ has to be taken in consideration, see value J_{1 min} in the product tables.

$$J_1 = \frac{L - \sum J}{2}$$

If an unsymmetrical dimension J₁ is needed it can be stated in the ordering code by using the definition of J₁ as shown in fig. 4.

Fig. 3

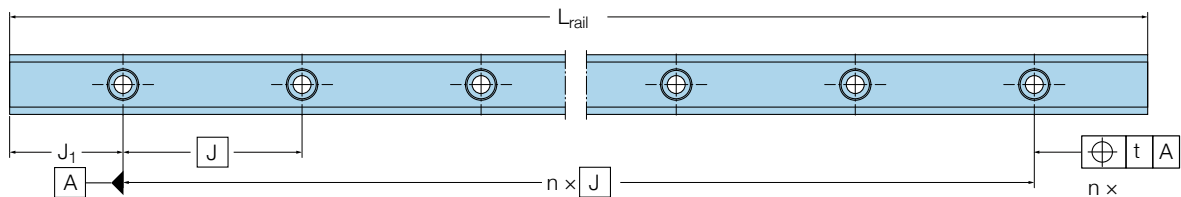
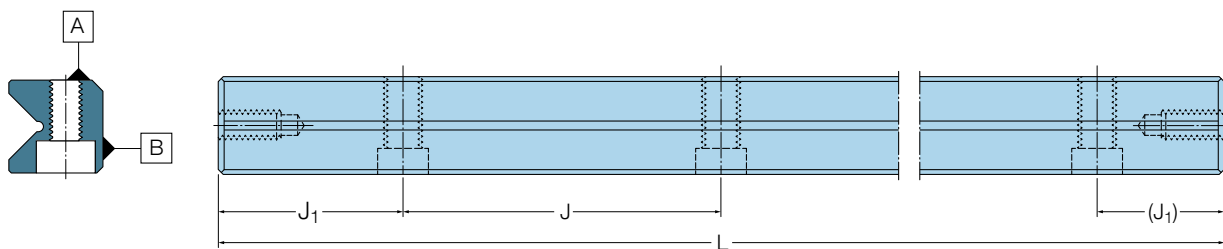

Fig. 4



4.1.8 Special mounting screws LWGD

Special mounting screws LWGD help to compensate for manufacturing tolerances. The screw strength class is at least 8.8. All dimensions are given in **table 3**.

Table 3

LWGD special mounting screws

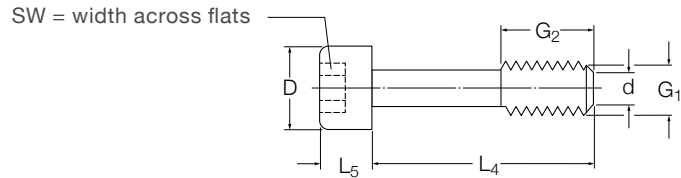

Designation	Dimensions			L4	L5	D	d	SW	Appropriate rail guide	Size
	G1	G2 mm								
-										
LWGD 3	M3	5	12	3	5	2,3	2,5	} LWR LWRE LWRM, LWRV LWRPM, LWRPV	4 2211 6 9	
LWGD 4	M3	5	16	3	5	2,3	2,5			
LWGD 2211	M4	5	14	4	6	3	3			
LWGD 6	M5	8	20	5	8	3,9	4			
LWGD 9	M6	12	30	6	8,5	4,6	5			
LWGD 12	M8	17	40	8	11,3	6,25	6		12	
LWGD 4020 ¹⁾	M6	10	25	6	9,4	4,6	5	LWM, LWV	4020	
LWGD 5025 ¹⁾	M6	10	30	6	9,4	4,6	5	LWM, LWV	5025	
LWGD 6035 ¹⁾	M8	12	40	8	12,5	6,3	6	LWM, LWV	6035	
LWGD 7040 ¹⁾	M10	17	50	10	15,2	7,9	8	LWM, LWV	7040	
LWGD 8050 ¹⁾	M12	20	60	12	17,2	9,6	10	LWM, LWV	8050	

¹⁾ Available on request.

4.1.9 Preloading

Precision rail guides with rolling elements and in clamped arrangement should always be mounted without clearance and thus with a certain preload. Preloading enhances the rigidity of the system as well as the running accuracy. Peaks of load at the end of the rolling element assemblies, caused by torque loads M_y and M_z are consequently decreased.

The magnitude of the adjustable preload depends on the actual application and can be up to 20% of the dynamic load carrying capacity of the rail guide. The presence of preload means that the load acting on the rolling elements must be reduced, and this should be taken into consideration when the operating conditions require high preload. Associated components need corresponding stiffness.

Rail guides can be preloaded in many ways. Some examples are shown in (→ **fig. 5** to **7**). The most common method is the use of set screws for adjustment. The number of these screws should at least be equal to the mounting holes in the rail.

Fig. 5

Preloading with set screws

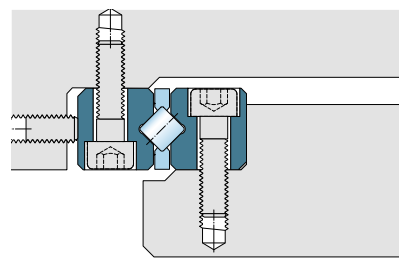
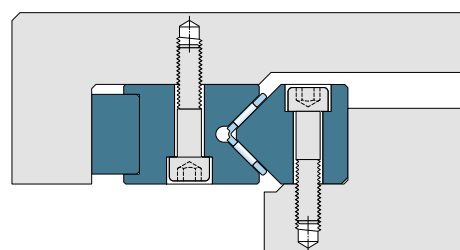

Fig. 6

Preloading with LWML rail



Experience is needed to use this method successfully, in order to avoid “pinching” the rail assembly. **Table 4** gives approximate values for a smoothly running precision rail guide system with a balance of rigidity and friction.

Preloading of rolling assemblies with any ACS system is done using the same values.

The use of adjustment bars or adjustment wedges is recommended in cases where large preloads are required or where high demands are placed on running accuracy. For needle roller assemblies, Ewellix can offer the LWML rail, which is equipped with a built-in adjustment wedge.

Fig. 7

Preloading with lateral wedge

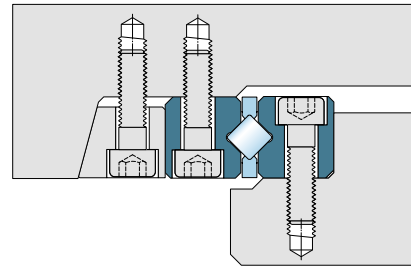

Table 4

Tightening torques of set screws

Rail type ¹⁾	Type of rolling element assembly	Set screw distance mm	Set screw	Factor for preload %	Tightening torque ²⁾ Ncm
–	–	mm	–	%	Ncm
LWRB 1	LWJK 1,588	10	M2	20	1,8
LWRB 2	LWJK 2	15	M3	10	1,7
LWR 3	LWAK3	25	M3	13	3
LWR 3	LWAK3	25	M4	13	4
LWR 6	LWAL6	50	M5	9	17
LWR 6	LWAL6	50	M6	9	20,4
LWR 9	LWAL9	100	M6	8	67,9
LWR 9	LWAL9	100	M8	8	90
LWR 12	LWAL12	100	M10	8	153,6
LWRE 3	LWAKE3	25	M3	7	6,2
LWRE 3	LWAKE3	25	M4	7	8,3
LWRE 2211	LWAKE3	40	M3	7	9,9
LWRE 2211	LWAKE3	40	M4	7	13,2
LWRE 4	LWAKE4	25	M3	5	9,5
LWRE 4	LWAKE4	25	M4	5	12,7
LWRE 6	LWAKE6	50	M5	3	26,9
LWRE 6	LWAKE6	50	M6	3	32,4
LWRE 9	LWAKE9	100	M6	3	102,2
LWRE 9	LWAKE9	100	M8	3	135,4
LWRM / LWRV 6	LWHV10	50	M6	5	96,9
LWRM / LWRV 6	LWHW10	50	M6	5	96,9
LWRM / LWRV 9	LWHV15	100	M8	2	161
LWRM / LWRV 9	LWHW15	100	M8	2	120,2
LWM / LWV 3015	LWHV10	40	M6	5	77,5
LWM / LWV 3015	LWHW10	40	M6	5	77,5
LWM / LWV 4020	LWHV15	80	M8	2	128,8
LWM / LWV 4020	LWHW15	80	M8	2	96,1
LWM / LWV 5025	LWHV15	80	M8	2	128,8
LWM / LWV 5025	LWHW15	80	M8	2	96,1
LWM / LWV 6035	LWHV20	100	M10	2	294,9
LWM / LWV 6035	LWHW20	100	M10	2	217,8
LWM / LWV 7040	LWHW25	100	M12	2	395,9
LWM / LWV 8050	LWHW30	100	M12	2	507,9

¹⁾ Precision rail guides with slide coating should not be preloaded.

²⁾ Tightening torque is given for dry, not lubricated set screws.

4.1.10 Tightening torques for mounting screws

Depending on the material of the adjacent components and the screw size, different values of tightening torques have to be used for mounting a precision rail guide (↳ **table 5**).

Given values are also valid for the special mounting screws LWGD.

Table 5

Tightening torque of mounting screws

Data for mounting screws in strength class 8.8

Material		Screw size	M2	M2,5	M3	M3,5	M4	M5	M6	M8	M10	M12	M14
Aluminum	Tightening torque	[Nm]	0,21	0,44	0,77	1,2	1,7	3,4	6	15	29	50	80
	Minimum screw-in length	[mm]	3,2	4	4,8	5,6	6,4	8	10	13	16	19	22
Cast iron	Tightening torque	[Nm]	0,25	0,52	0,92	1,4	2,1	4,1	7	17	34	60	94
	Minimum screw-in length	[mm]	3	3,8	4,5	5,3	6	7,5	9	12	15	18	21
Steel	Tightening torque	[Nm]	0,3	0,61	1,1	1,6	2,4	4,8	8	20	40	69	110
	Minimum screw-in length	[mm]	2,4	3	3,6	4,2	4,8	6	7,2	10	12	14	17

4.2 Mounting

4.2.1 Important requirements

The following instructions describe the mounting procedures for a Ewellix precision rail guide system. Read these instructions carefully before starting the installation process. Skill and cleanliness are essential when mounting precision rail guides to obtain optimum performance and to avoid mounting-induced bearing failure. Mounting should be carried out in a dry, dust-free room away from metal-working machines and other machinery producing swarf or dust. Prior to mounting the rail guides, all necessary parts and equipment should be at hand. Appropriate tools and measuring devices are to be used at all times. Rail guides are precision products and should be handled with due care. Not following these instructions could reduce system service life or create a safety risk.

4.2.2 General mounting rules

All parts of the linear guiding system should be carefully cleaned and deburred as well as demagnetization and the accuracy of form and dimension of all adjacent components checked against the specification, (L→ chapter 4.1.3). The rails should not be removed from their original packaging until immediately before mounting, to minimize the risk of contamination. After unwrapping, the corrosion inhibitor must be removed. When using SKF LGEP2 grease, the corrosion inhibitor can remain on the raceways. The reference surfaces of the rails and the mounting surfaces of the adjacent parts should be carefully cleaned and lightly oiled to prevent contact corrosion during operation. The reference surface A is generally on the opposite side of the Ewellix label. Apply the chosen lubricant onto the raceways and the rolling element assemblies prior to mounting.

NOTE: To retain the high performance of precision rail guides, it is recommended not to mix rails from different packages (L→ chapter 2.1.12).

4.2.3 Mounting of rail guides without Anti-Creeping System

Mounting of a rail guide in a clamped arrangement should take place in the following sequence (fig. 8):

1. Inner rails **3** and **4** are pressed against the mounting surfaces and bolted down, applying the prescribed torque.
2. Fixed rail **1** is pressed against the mating mounting surfaces and bolted down, applying the prescribed torque.
3. The outer rail **2** is pressed onto its counterpart and bolted lightly in position.
4. The lubricated rolling element assemblies **5** and **6** are moved to their desired position (usually centred).
5. The outer rail **2** is used for preload adjustment because a system in clamped arrangement has to be operated with zero clearance or with preload, depending on the application. The preload is adjusted by means of set screws **7** with the help of a torque wrench. For the correct adjustment sequence, follow the numbers on the set screws as described in Fig. 9. Be sure to tighten the set screws from inside to outside, and have rolling elements underneath the corresponding set screws.



Fig. 8

Mounting sequence

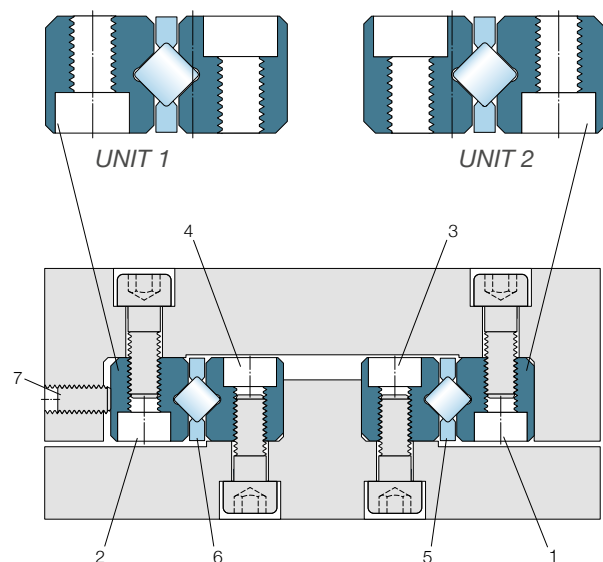

Recommended tightening torques, which should only be considered as approximate values, are given in **table 4, chapter 4.1.9**.

6. The fixing bolts on outer rail **2** are tightened by applying the prescribed torque.
7. The running accuracy of the slide assembly is checked.
8. Measures should be taken that the set screws cannot get lost by selflocking. Several options are feasible:
 - 8.1 they could be secured by adhesive
 - 8.2 a cover could prevent loss of set screws.
9. The end pieces, if applicable, are mounted.
10. The external end stops of the slide assembly are mounted. The rolling element assemblies should not be used as counterparts for the end stops.

8. The fixing bolts on the outer rail **2** are tightened by applying the prescribed torque.
9. The running accuracy of the slide assembly is checked
10. Measures should be taken that the set screws cannot get lost by selflocking. Several options are feasible:
 - 10.1 they could be secured by an adhesive
 - 10.2 a cover could prevent loss of set screws.
11. The end pieces, if applicable, are mounted.
12. The external end stops of the slide assembly are mounted. The rolling element assemblies should not be used as counterparts for the end stops.

4.2.4 Mounting of rail guides with Anti-Creeping System

In order to avoid damage to the Anti-Creeping System, the rails have to be mounted as pre-assembled units with the rolling element assemblies correctly positioned. Any force subjected to the ACS control gear will damage it.

The following instructions are valid for all types of Anti-Creeping Systems (ACS, ACSM, ACSZ).

1. Outer rail **1**, inner rail **3**, and lubricated rolling element assembly **5** are put together as unit **1** with the rolling element assembly in its correct position – typically centred.
2. Unit **2** should be prepared in the same way by using inner rail **4**, outer rail **2** and rolling element assembly **6**.
3. Both units are pushed in from the front side to the desired position between the bottom and top part.
4. Unit **1** is pressed against the mounting surfaces and bolted down, applying the prescribed torque.
5. Inner rail **4** is pressed against the mating mounting surfaces and bolted down, applying the prescribed torque.
6. Outer rail **2** is mounted onto its counterpart, and bolted lightly in position.
7. The outer rail **2** is used for preload adjustment because a system in clamped arrangement has to be operated with zero clearance or with preload, depending on the application. The preload is adjusted by means of set screws **7** with the help of a torque wrench. For the correct adjustment sequence, follow the numbers on the set screws as described in **fig. 9**. Be sure to tighten the set screws from inside to outside and have rolling elements underneath the corresponding set screws. Recommended tightening torques, which should only be considered as approximate values, are given in **table 4, chapter 4.1.9**.

Fig. 9

Preload sequence

Moving part in centre position; screws 1, 2, 3

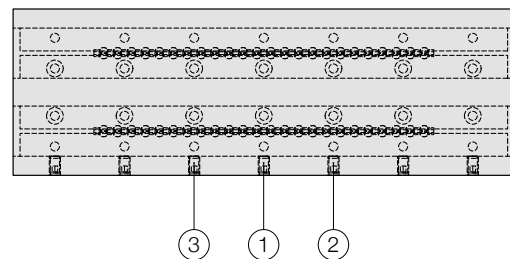

Moving part in end position; screws 4, 6

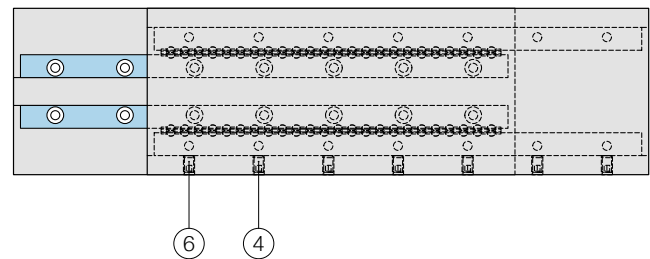

Moving part in other end position, screws 5, 7

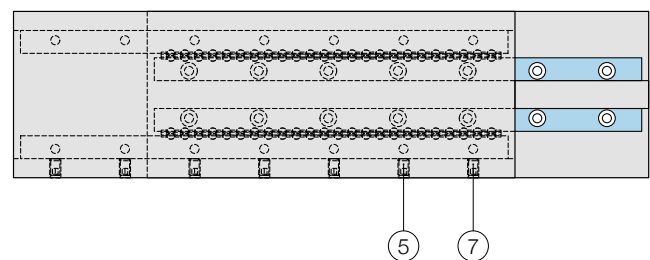

4.3 Maintenance

4.3.1 Lubrication

Ewellix precision rail guides usually require very small quantities of lubricant. Both grease and oil can be used.

Lubricants with solid additives, or grinding emulsions and coolants are unsuitable.

Under normal operating conditions, grease is generally used to lubricate rail guides. Compared to oil, grease is more easily retained in the bearing arrangement, particularly if the rail guides are mounted in an inclined or vertical position. Grease also helps to prevent the ingress of contaminants and humidity.

Since rail guides, particularly in low speed applications, operate almost exclusively under borderline or mixed friction conditions, the use of grease with extreme pressure (EP) additives is advisable. Ewellix recommends using SKF bearing grease LGEP2. This grease is based on lithium soap and mineral oil. It has excellent water repellent and corrosion resistance properties and can be used in the temperature range from -20°C to $+110^{\circ}\text{C}$.

Oil lubrication is often employed in situations where neighbouring machine components are oil lubricated, or where high speeds of travel are involved. A simple method of lubrication with oil is the oil drop method. Ordinary mineral oil with EP additives and viscosities in the range of ISO VG 45 to 200 is suitable.

Lubricant can be supplied to the rail guides most easily using the lateral gap between the rails. If this is not possible because of the design of the arrangement, rails provided with lubrication holes can be supplied, in which case a drawing should be forwarded to Ewellix, indicating the size and location of the holes. It is also possible to connect central lubrication units, which can be offered by Ewellix. Be aware that the ACS control gears and its axis must also be lubricated.

4.3.2 Relubrication interval

There are no general rules given for re-lubrication intervals for precision rail guides, as these must be individually determined for each application. However, we recommend re-lubricating at least once a year.

4.3.3 Repairs

If a precision rail guide system has reached the end of its service life and needs to be replaced, Ewellix recommends replacing the complete system. When re-ordering, please identify the size, rail length, J_1 dimension (distance from rail end to first mounting hole), hole type and length of stroke or rolling element assembly.

4.3.4 Stationary conditions / shipping / storage

If a precision rail guide is stationary for long periods and subjected to vibration from external sources, micro movement in the contact zone between rolling elements and raceways will lead to damage of those surfaces. This damage can result in significant increase of the vibration and therefore the running noises, and premature failure due to material fatigue. Damage of this kind should be avoided at all costs, for instance by isolating the bearings from external vibration and by taking suitable precautions during transport.

5

Ordering Key

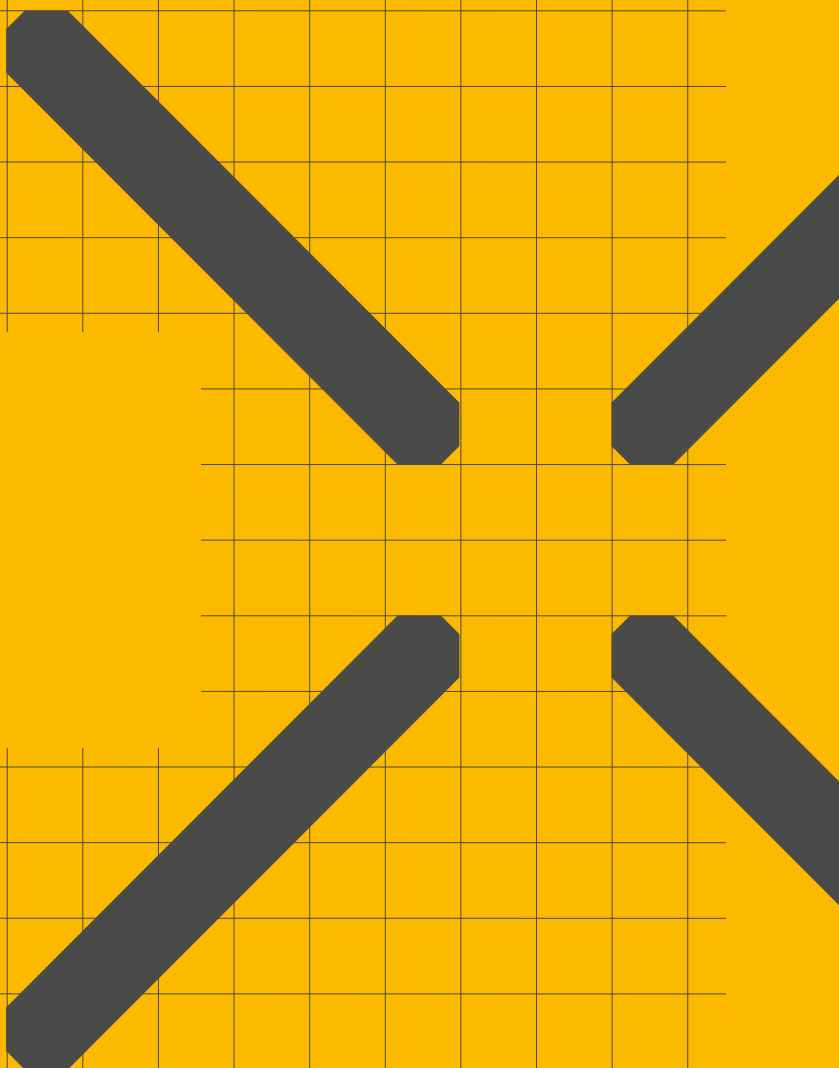

Ordering key precision rails

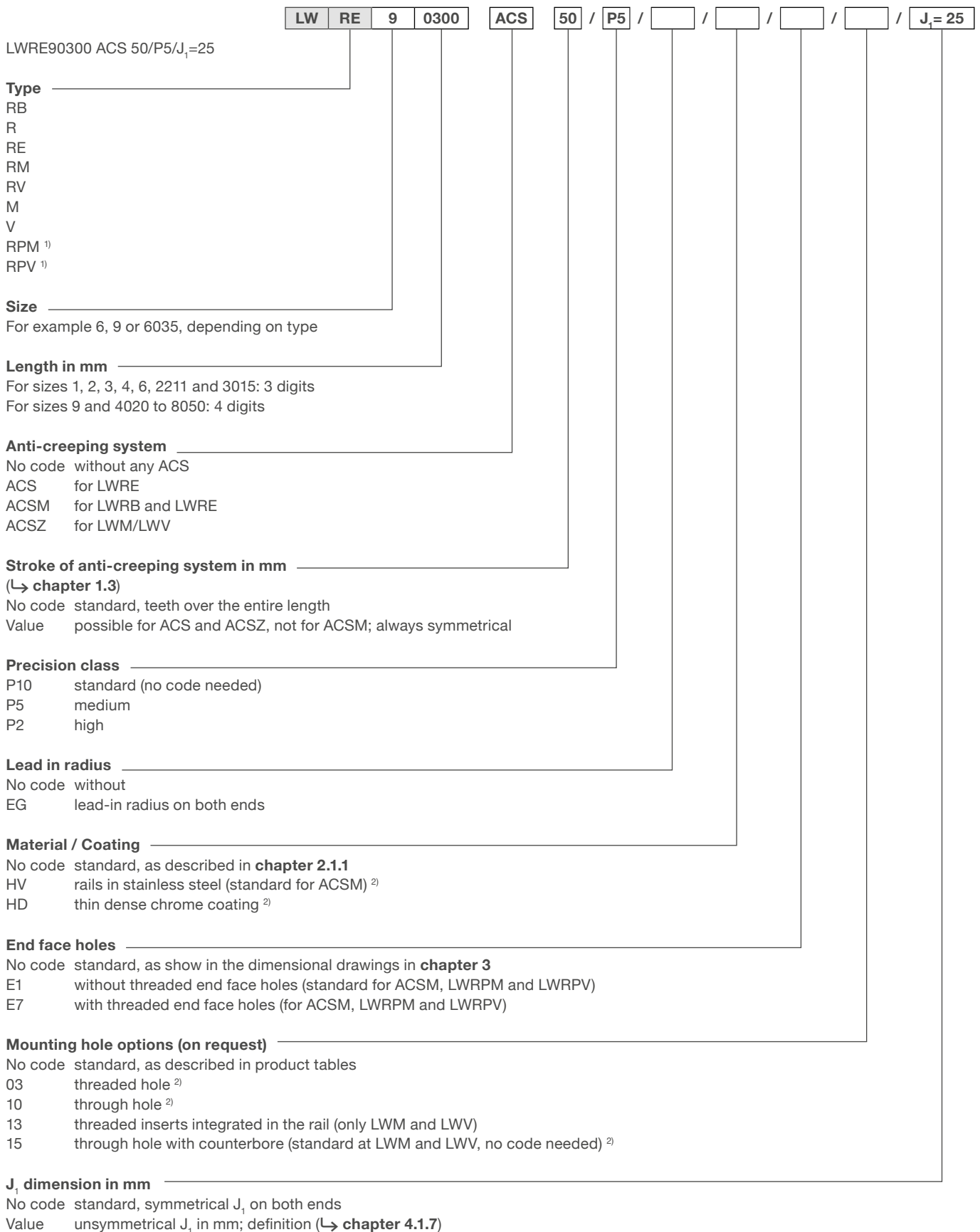

¹⁾ In precision class P10 only

²⁾ Delivery time on request

Ordering key rolling element assemblies



LWAKE9x13 ACS

Type

- JK for LWRB
- AL, AK for LWR
- AKE for LWRE
- HV, HW for LWRM/V and LWM/V

Size

- 1, 2 for LWJK
- 3 for LWAK
- 6, 9, 12 for LWAL
- 3, 4, 6, 9 for LWAKE
- 10, 15 for LWHV
- 10, 15, 20, 25, 30 for LWHW

Length

Number of rolling elements for ball and roller assemblies
Length in mm for needle roller assemblies

Anti-creeping system

- No code without any ACS
- ACS for LWAKE
- ACSM for LWJK and LWAKE
- ACSZ for LWHW

Precision class

- No code standard, as described in product tables
- G1 high (only available for needle roller assemblies)

Ordering key special mounting screws



LWGD 9

Size

- 3, 4, 6, 9, 12, 2211 for all rails of the Modular Range and size 2211
- 4020¹⁾, 5025¹⁾, 6035¹⁾, 7040¹⁾, 8050¹⁾ for LWM/V

Generally the same size as for the rail has to be entered.

¹⁾ Available on request

Ordering key end pieces

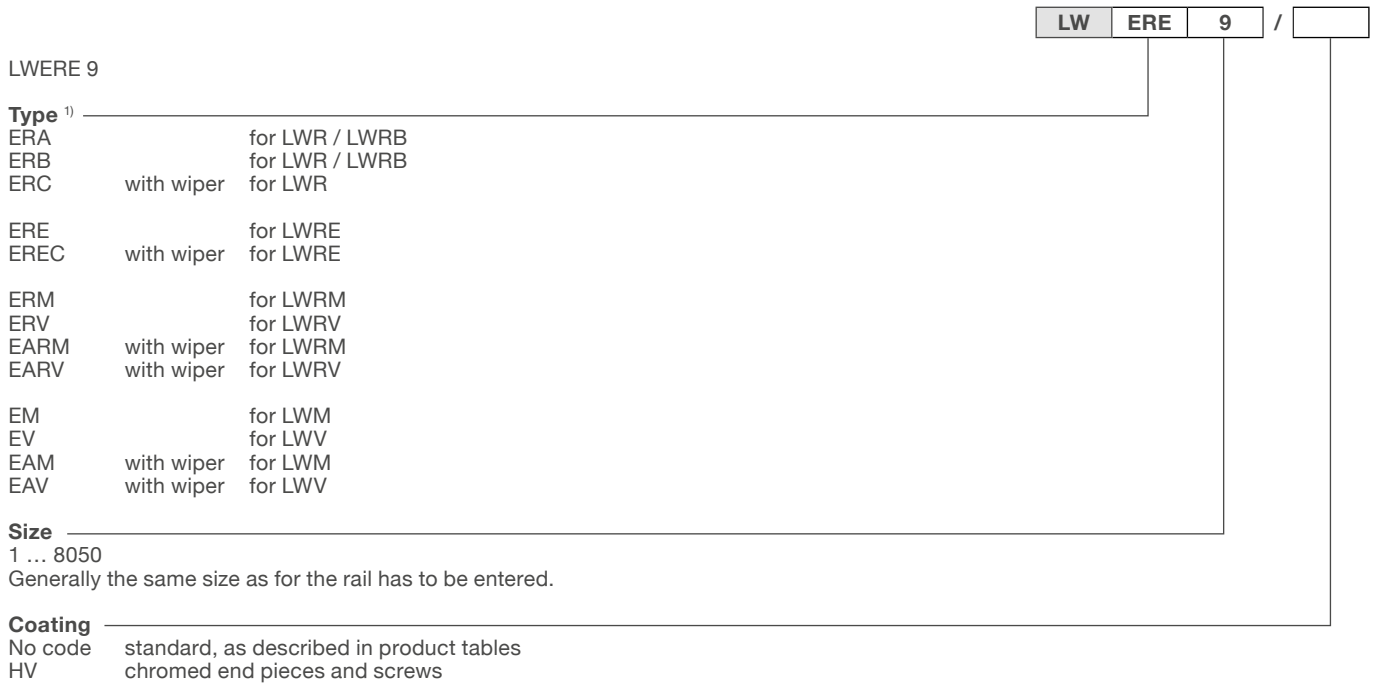

¹⁾ Take table 2, Chapter 4.1.4, in consideration

Ordering key precision rail guides in kit packaging

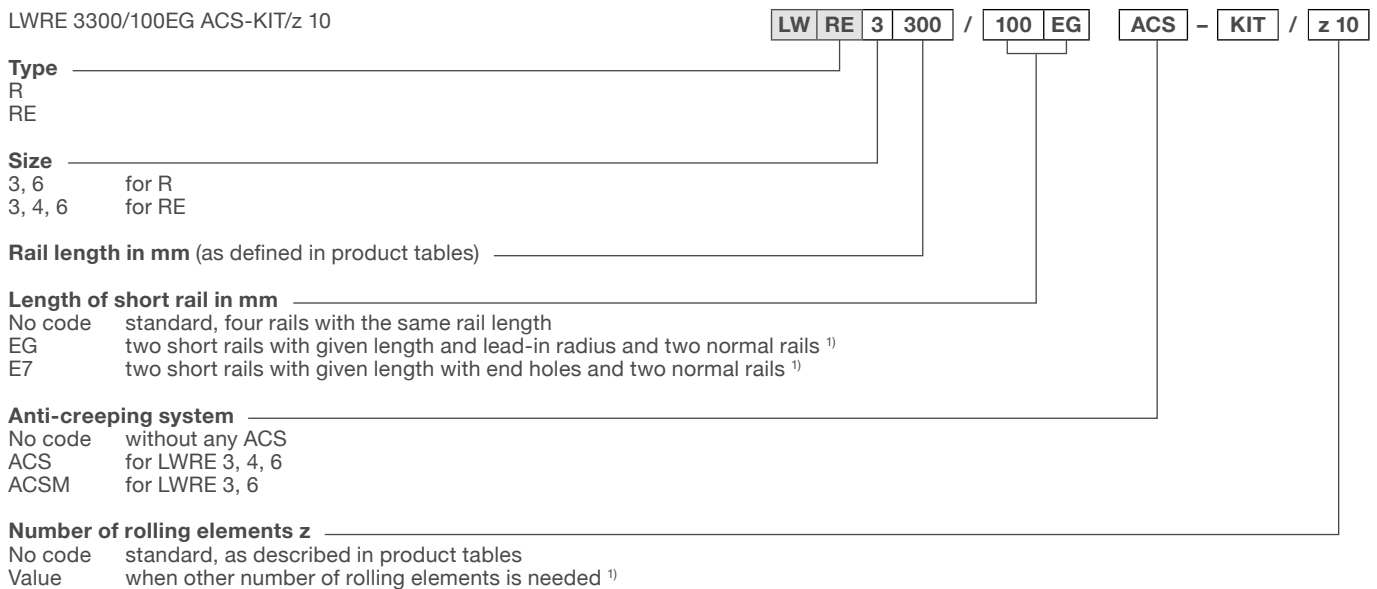

¹⁾ Delivery time on request

Ordering key LZM

LZMHS9-26T1P1S

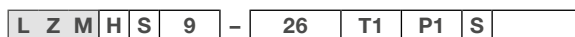

Miniature slide

Rail

- H Standard rail
- W Wide rail ¹⁾

Size

- 7 Size 7
- 9 Size 9
- 12 Size 12
- 15 Size 15

Length L

Standard length, selected from product range tables (↳ **chapter 3.11**) or Customized length, in 1 mm increments ¹⁾

Preload

- T0 Light clearance; standard - no need to specify
- T1 Zero clearance to light preload
- T2 Preloaded system

Precision class

- P5 Standard - no need to specify
- P1 High

Stroke in mm

Needed only for customized LZM,
For standard lengths - no need to specify

¹⁾ On request

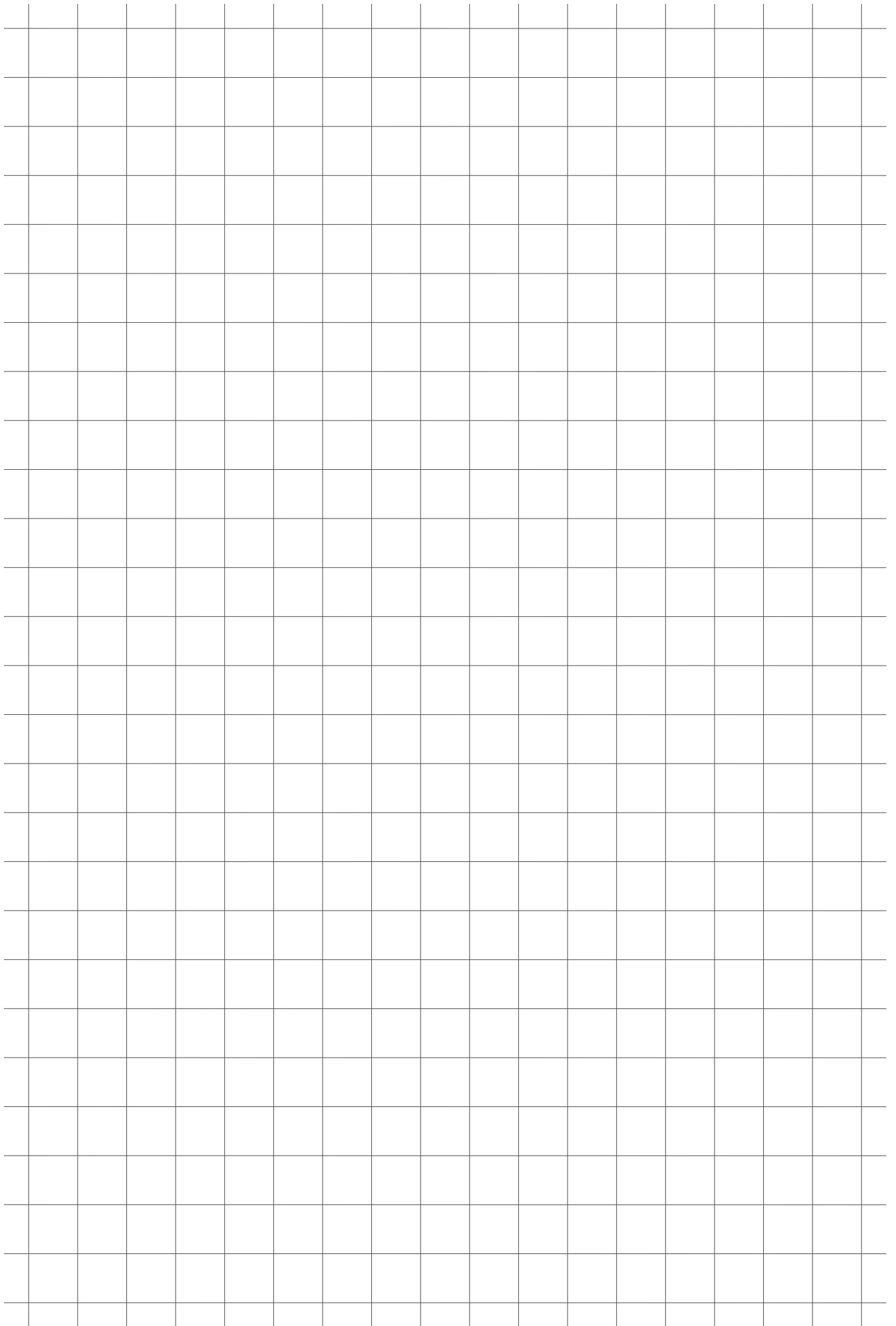

6

Specification Sheet

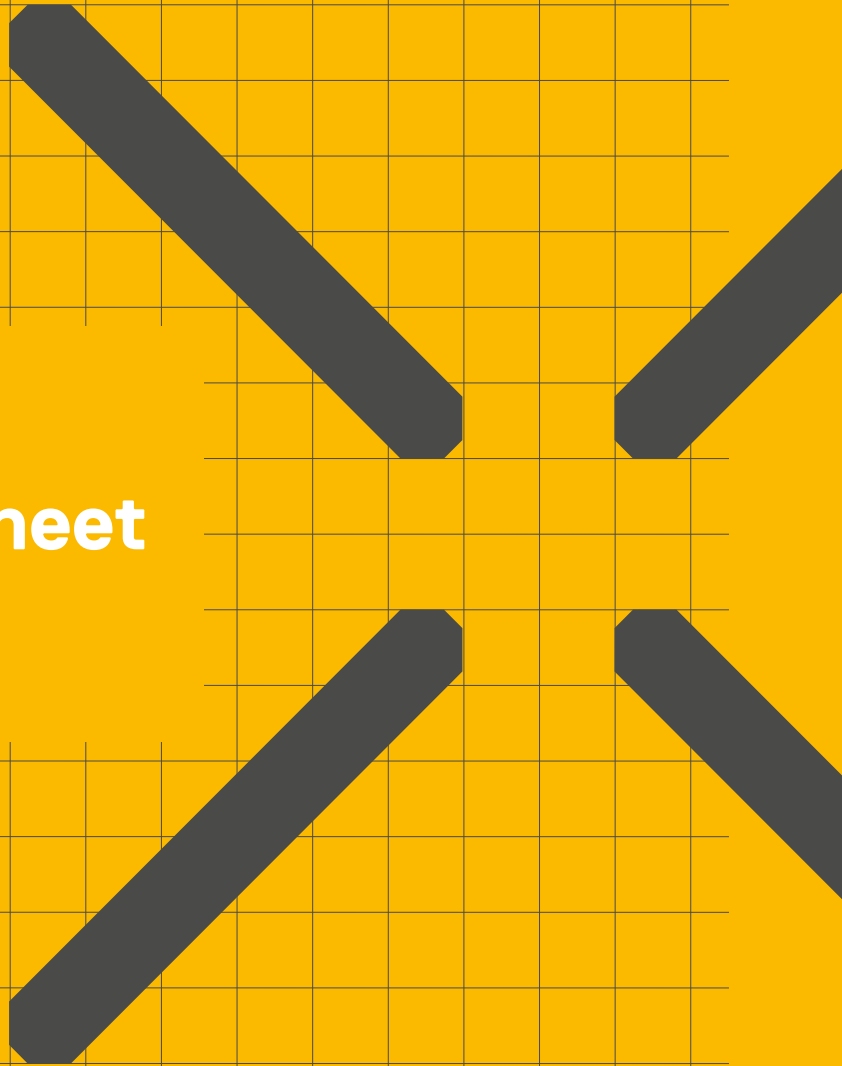

Specification sheet – Precision rail guides

Please complete the form with all available information and send it to your Ewellix representative or authorized distributor for product selection.

Ewellix contact	Date
-----------------	------

General information

Customer

Company		
Address 1		
Address 2		
Post code / Zip	City	State
Country		

Contact

Contact name	
Job title	
Department	
Phone (including country code)	Mobile (including country code)
Mail	

Project title

Reason for request

Current product / brand	Description	
<input type="radio"/> Replacement	<input type="radio"/> New design	<input type="radio"/> Other

Application / Industry

<input type="radio"/> Factory automation	<input type="radio"/> Food and beverage	<input type="radio"/> Machine tools	Description
<input type="radio"/> Medical	<input type="radio"/> Semiconductor	<input type="radio"/> Other	

Export control and Ewellix policy (mandatory to mark)

<input type="radio"/> The application is not subsidiary or part of industry of national defence and/or nuclear (also not with details of the function). The application is civil.
--

Commercial information

General

<input type="radio"/> One shot business	Quantity, pcs	Batch size, pcs	Start of supply, YYYY MM DD	Target price / each	Currency
<input type="radio"/> Yearly repeating business					

Application description

Specification sheet – Precision rail guides

Stroke mm	Rail length mm	Length of shorter rail mm	Distance B_1 mm	Distance $B_1 + A$ mm	Guiding system Maximum height mm <input type="radio"/> No constraints
--------------	-------------------	------------------------------	----------------------	--------------------------	--

Required service life distance or time (fill in all fields)				Required static safety (in accordance to your business and application)
Distance km	Total time h	Period of one cycle s	Stroke of one cycle mm	

Maximum speed ¹⁾ m/s	Maximum acceleration ¹⁾ m/s ²	Rigidity of guiding system N/μm <input type="radio"/> No specific requirements	Running accuracy of guiding system Parallelism in height μm Parallelism in sideward direction μm
------------------------------------	--	--	--

¹⁾ Here the maximum values. Enter load phase specific values in table "External loads and load phases"

Environment

Presence of dust, dirt or fluids <input type="radio"/> Clean environment, e.g. laboratory <input type="radio"/> Standard industrial environment <input type="radio"/> Dirty environment, e.g. milling machine	Requirements on friction <input type="radio"/> Lowest possible friction <input type="radio"/> Standard friction <input type="radio"/> No requirement
<input type="radio"/> Humid or corrosive environment If yes, please describe:	Preferred material <input type="radio"/> No preference (standard) <input type="radio"/> Stainless steel <input type="radio"/> Coated steel

Temperature [°C]

Minimum	Operating	Maximum	<input type="radio"/> Shockloads or vibrations If yes, please describe:
---------	-----------	---------	--

Lubricant

<input type="radio"/> Standard (SKF grease LGEP2)	<input type="radio"/> Other Please specify:
---	--

Sketch of the application (or attach a drawing)

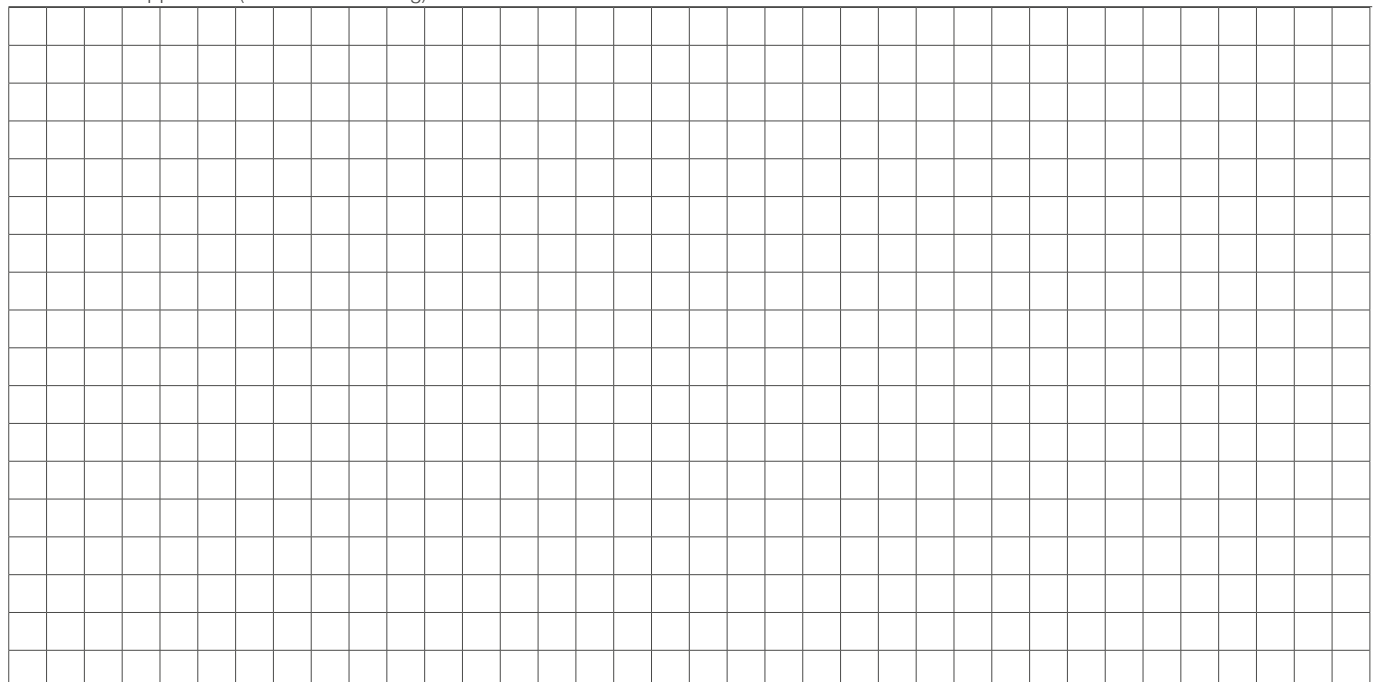

Product details

Product designation (if already known)

Precision class of rail

 P10 (Standard) P5 (Medium) P2 (High)

Designation of rolling element assembly (if already known)

Anti-creeping system needed (recommended for high acceleration or vertical systems)

 Yes No

Needed accessories

 End pieces Designation

 End pieces with wipers (requires long and short rails) Designation

 Special mounting screws – LWGD

Precision rail guides mounted into a complete system

 GCL GCLA System with drive, e.g. roller screw

Specification sheet – Precision rail guides

Input for dimensioning calculation

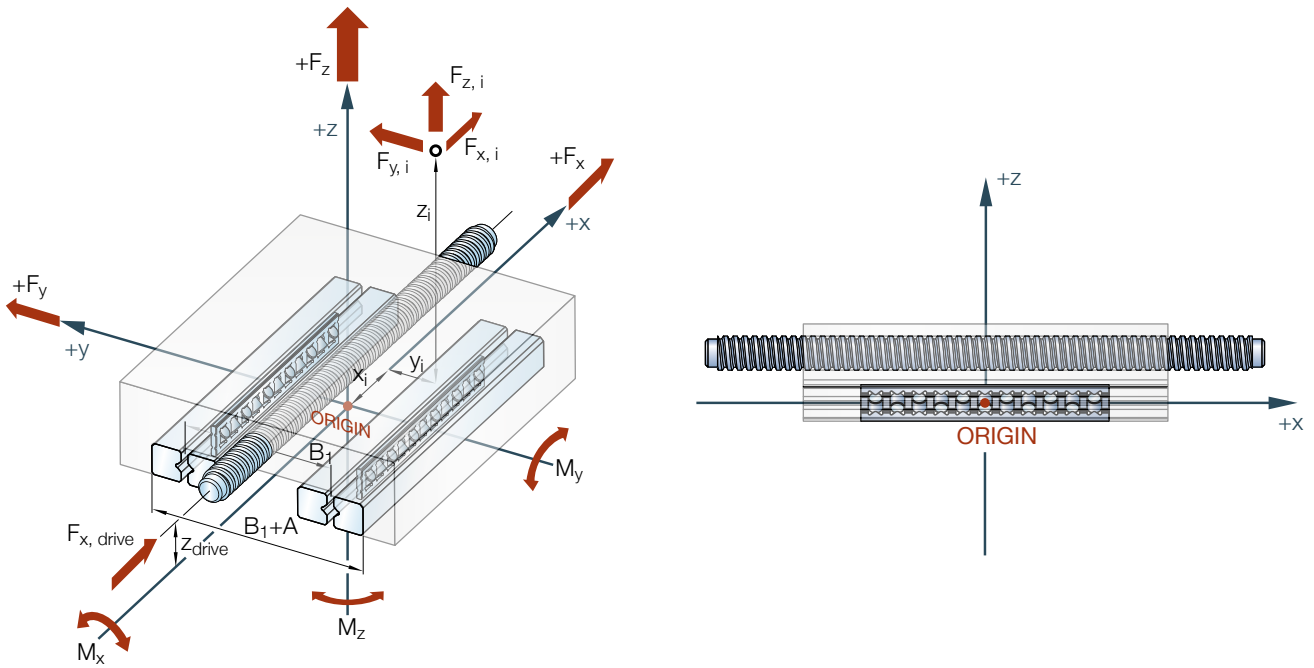

Moving direction (set coordinate system accordingly)

Please specify:

- Horizontal
 Vertical
 Other

External loads and load phases

Forces in N, Lever arms in mm measured from defined origin (see graphics above). If the application has more than 3 load phases, please copy this page.

Load phase 1				Load phase 2				Load phase 3			
Stroke	mm			Stroke	mm			Stroke	mm		
Acceleration	mm/s ²			Acceleration	mm/s ²			Acceleration	mm/s ²		
Speed	m/s			Speed	m/s			Speed	m/s		
Force F_x	Lever arms in			Force F_x	Lever arms in			Force F_x	Lever arms in		
	x	y	z		x	y	z		x	y	z
Force F_y	x	y	z	Force F_y	x	y	z	Force F_y	x	y	z
Force F_z	x	y	z	Force F_z	x	y	z	Force F_z	x	y	z



ewellix.com

© Ewellix

All contents of this publication are the property of Ewellix, and may not be reproduced or given to third parties (even extracts) without permission. Although great care has been taken in the production of this catalog, Ewellix does not take any responsibility for damage or other loss resulting from omissions or typographical errors. The photo may differ slightly in appearance from the actual product. Due to continuous improvements being made in our products, the product's appearance and specifications are subject to change without notice.

PUB IL-06001/3-EN-April 2021

SKF and SKF logo are trademarks of the SKF Group